



User Manual

D8 Smart Diagnosis System



Please read this user manual carefully before using the D8 Smart Diagnosis System. When reading the manual, please pay attention to the words “Note” or “Caution”, and read them carefully for appropriate operation.

TRADEMARKS

XTOOL is a registered trademark of Shenzhen Xtooltech Intelligent CO., LTD.

In countries where the trademarks, service marks, domain names, logos and the name of the company are not registered, XTOOL claims that it still reserves the ownership of the unregistered trademarks, service marks, domain names, logos and the company name. All other marks for the other products and the company’s name mentioned in the manual still belong to the original registered company.

You may not use the trademarks, service marks, domain names, logo and company name of XTOOL or other companies mentioned without written permission from the trademark holder.

XTOOL reserves the right to the final interpretation of this manual content.

COPYRIGHT

Without the written consent of Shenzhen Xtooltech Intelligent Co., Ltd., any company or individual shall not copy or backup this operation manual in any form (electronic, mechanical, photocopying, recording or other forms).

DECLARATION

This manual is designed for the usage of the D8 Smart Diagnosis System and provides operating instructions and product descriptions for users of the D8 Smart Diagnostic system.

No part of this manual can be reproduced, stored in a retrieval system or transmitted, in any form or by any means (electronic, mechanical, photocopying, recording, or otherwise), without the prior written permission of XTOOL.

Use the device only as described in this manual. XTOOL is not responsible for any consequences of violating the laws and regulations caused by using the product or its data information

XTOOL shall not be liable for any incidental or consequential damages or for any economic consequential damages arising from the accidents of individual users and the third parties, misuse or abuse of the device, unauthorized change or repair of the device,

or the failure made by the user not to use the product according to the manual.

All information, specifications and illustrations in this manual are based on the latest configurations and functions available at the time of printing. XTOOL reserves the right to make changes at any time without notice.

OPERATION INSTRUCTIONS

For safe operation, please follow the instructions below:

- Keep the device away from heat or fumes when you use it.
- If the vehicle battery contains acid, please keep your hands and skin or fire sources away from the battery during testing.
- The exhaust gas of the vehicle contains harmful chemicals, please ensure adequate ventilation.
- Do not touch the cooling system components or exhaust manifolds when the engine is running due to the high temperatures reached.
- Make sure the car is securely parked, Neutral is selected or the selector is at P or N position to prevent the vehicle from moving when the engine starts.
- Make sure the (DLC) diagnostic link connector is functioning properly before starting the test to avoid damage to the Diagnostic Tablet.

- Do not switch off the power or unplug the connectors during testing, otherwise, you may damage the ECU and/or the Diagnostic Tablet.

CAUTIONS!

- Avoid shaking or dismantling the unit as it may damage the internal components.
- Do not use hard or sharp objects to touch the LCD screen;
- Do not use excessive force;
- Do not expose the screen to strong sunlight for a long period.
- Please keep it away from water, moisture, high temperature or very low temperature.
- If necessary, calibrate the screen before testing to ensure the accuracy of LCD performance.
- Keep the main unit away from strong magnetic fields.

AFTERSALES-SERVICES

 E-Mail: supporting@xtooltech.com

 Tel: +86 755 21670995 or +86 755 86267858 (China)

 Official Website: www.xtooltech.com

CONTENT

TRADEMARKS.....	I
COPYRIGHT.....	II
DECLARATION.....	II
OPERATION INSTRUCTIONS.....	III
CAUTIONS!.....	IV
AFTERSALES-SERVICES.....	IV
CONTENT.....	I
1 GENERAL INTRODUCTION.....	5
Tablet.....	5
<i>Front View of Tablet.....</i>	6
<i>Back View of Tablet.....</i>	7
<i>Host Ports.....</i>	8
Technical Specifications.....	9
Packing List.....	10
2 GETTING STARTED.....	11
Guide to Activation.....	11
Main Interface.....	14
<i>Operation system.....</i>	14
<i>Diagnosis system entrance.....</i>	17
<i>Function Buttons.....</i>	18

<i>Navigation Buttons</i>	19
<i>Notification Bar</i>	20
Delete Software.....	21
Factory reset.....	22
3 UPDATE	24
4 DIAGNOSIS	25
Vehicle Connection.....	25
Diagnosis.....	27
<i>Vehicle Selection</i>	27
<i>Basic functions</i>	32
5 SPECIAL FUNCTIONS	41
Oil Light Reset.....	42
EPB.....	43
SAS.....	44
DPF.....	44
BMS Reset.....	46
Throttle.....	47
TPMS Reset.....	47
ABS Bleeding.....	48
Injector Coding.....	48
Gearbox Match.....	49
Key Programming.....	49

Suspension.....	51
Windows Initialization.....	52
Seat Calibration.....	52
Headlight.....	52
ECU Configuration.....	53
*A/F Reset.....	53
*Stop/Start Reset.....	54
Airbag Reset.....	54
Instrument Cluster.....	54
*Language Change.....	55
Transport Mode.....	55
Tire Upgrade.....	55
Gear Learning.....	55
Power Balance.....	56
Electronic Pump Activation.....	58
EEPROM.....	58
6 REPORT.....	58
Report.....	59
Replay.....	63
File Manager.....	63
7 SETTINGS.....	64
Language.....	65

Units.....	66
My Workshop Info.....	67
VCI Information.....	68
About.....	69
8 REMOTE ASSISTANCE.....	71
9 FAQ.....	73
Q1: Failed to generate diagnosis report.....	73
Q2: How to print diagnosis report.....	75
Q3: Failed to extract files.....	76
Q4: Mailbox supported.....	76
Q5: How to make an appointment for remote support.....	76
Q6: How to generate and upload diagnostic log files.....	77
Q7: How to switch language.....	77
Q8: Failed to diagnose vehicle.....	77
Q9: Failed to activate or register.....	78
Q10: Failed to turn on when charging.....	78
Q11: Failed to open the diagnosis app.....	79

1 GENERAL INTRODUCTION

The D8 smart diagnostic system is an advanced scanning tool based on the Android operating system. It supports multi-language switching and is suitable for different countries and regions. The advantage of this OBD II scanner is not only its comprehensive functions, including complete system diagnosis, all OBD II functions, various reset functions can also achieve a faster and more accurate diagnosis.

TABLET

The main unit of the D8 is the tablet, which has a built-in VCI module, which can be directly connected to the tablet and the car with the main test cable, without the need to connect to an external VCI box via Bluetooth.

FRONT VIEW OF TABLET



Fig 1-1 Tablet Front View

The front of the main unit is a touchable display screen, you can use your fingers to operate on the screen to complete the car diagnosis.

BACK VIEW OF TABLET

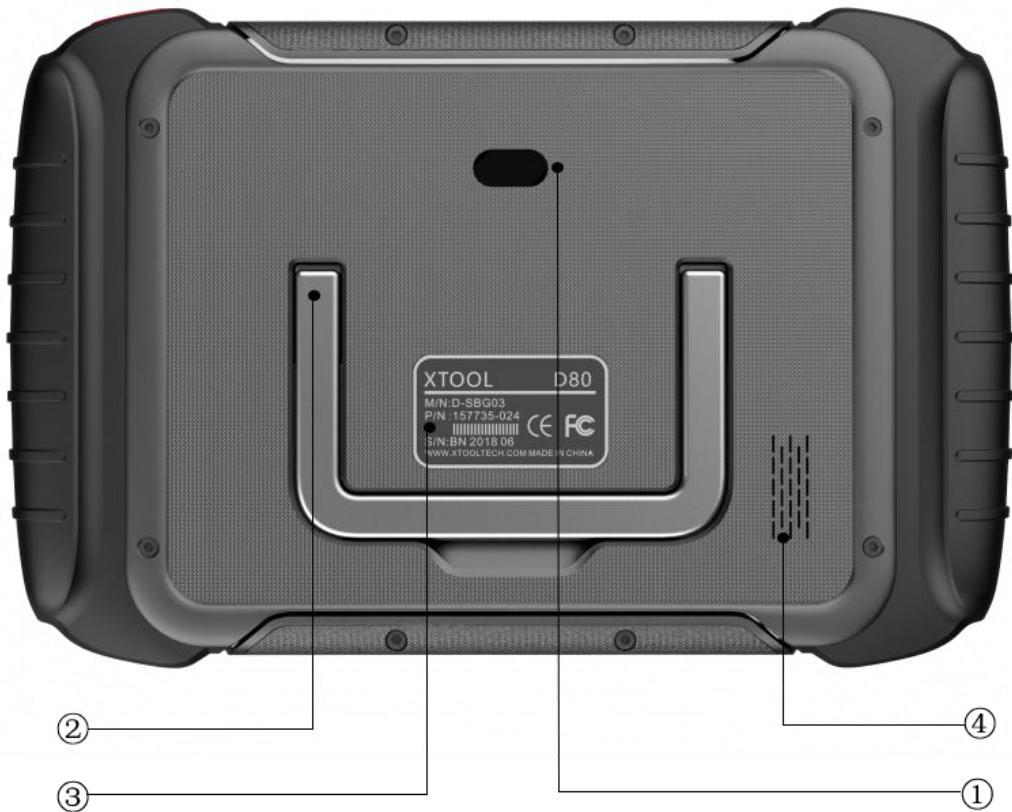

Fig 1-2 Tablet Back View

- ① **Camera:** 8-megapixel camera, for taking pictures.
- ② **Tablet Holder:** Used to support the tablet, flexible adjustment of the tablet height as needed.
- ③ **Nameplate:** Display the basic information about the tablet such as product name and model etc.
- ④ **Loudspeaker:** It supports playing external sounds.

HOST PORTS



Fig 1-3 Tablet Host Ports

- ① **USB 3.0 port:** Data transfer interface for tablet communication and diagnostics.
- ② **VGA port:** Diagnostic communication interface, which can be used for diagnosis.
- ③ **DC charging port:** Charging port, connected to the charger can be charged.
- ④ **Power button:** Long press to turn on/off, short press to rest/brighten the screen.

TECHNICAL SPECIFICATIONS

Table 1-1 Specification

Item	Description
OS	Android
Processor	Quad-core processor 1.8GHz
RAM	2G
ROM	64G
Display	8-inch capacitive, 1024×768 resolution
Connectivity	<ul style="list-style-type: none">● USB● Wi-Fi
Camera	8-megapixel autofocus rear camera with flash
Sensor	Gravity sensor
Audio Input/ Audio Output	Microphone/ Loudspeaker
Ports	<ul style="list-style-type: none">● USB● DC charging port● VGA port
Battery	10000mAh 3.7V lithium polymer battery
Input Voltage	12V DC
Operating Temperature	-10~50°C
Relative Humidity	< 90%
Dimensions	274.0×175.0×33.8 mm

PACKING LIST

Table 1-2 Packing List

Category	No.	Name	QTY
Test	1	OBD II-16	1
Connectors	2	DB15 to VGA Cable	1
and Cables	3	USB 3.0 Cable	1
Adaptor	1	DC12V(AC100~240V) 3A	1
	2	US power cable	1
	3	EU power cable	1
Main Unit	1	P804	1
Accessories	1	Tool kit	1
	2	Certificate of Quality	1
	3	Packing List	1
	4	User Manual	1
	5	Carton	1

*Note

To better protect the battery, it is recommended that the diagnosis device be charged at an ambient temperature of 0~40°C!

2 GETTING STARTED

GUIDE TO ACTIVATION

After first-time users press and hold the power button to turn on the system, the system will automatically enter the guide process and request to select the language for the operating system.

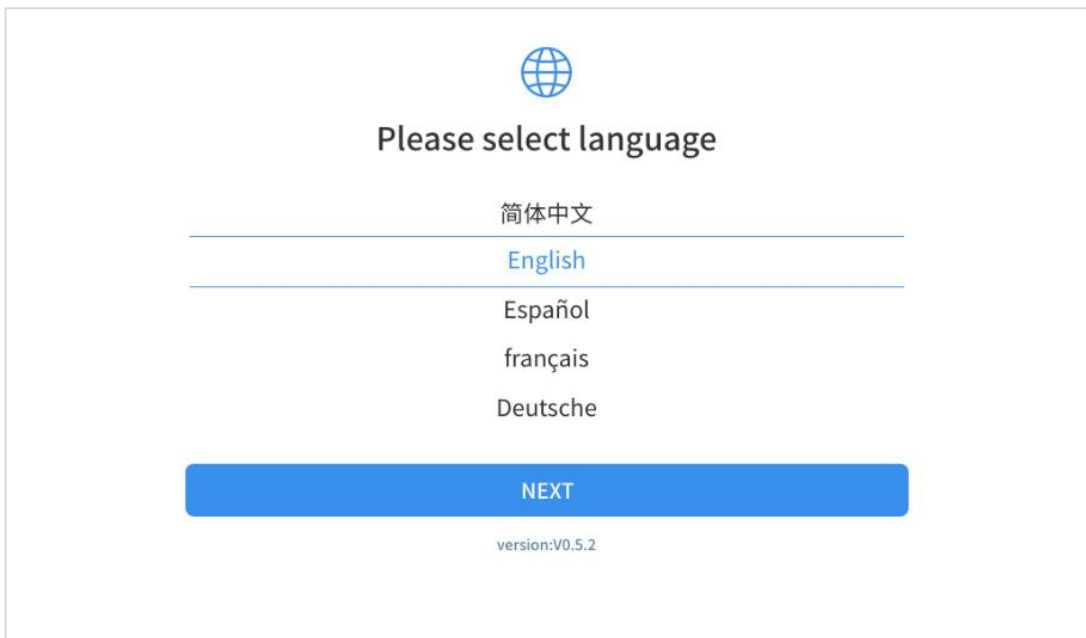

Fig 2-1

After setting the system language, you will enter the activation page, as shown in the figure below. You can also click the "**Trial**" button in the upper right corner to check the basic functions before your activation.

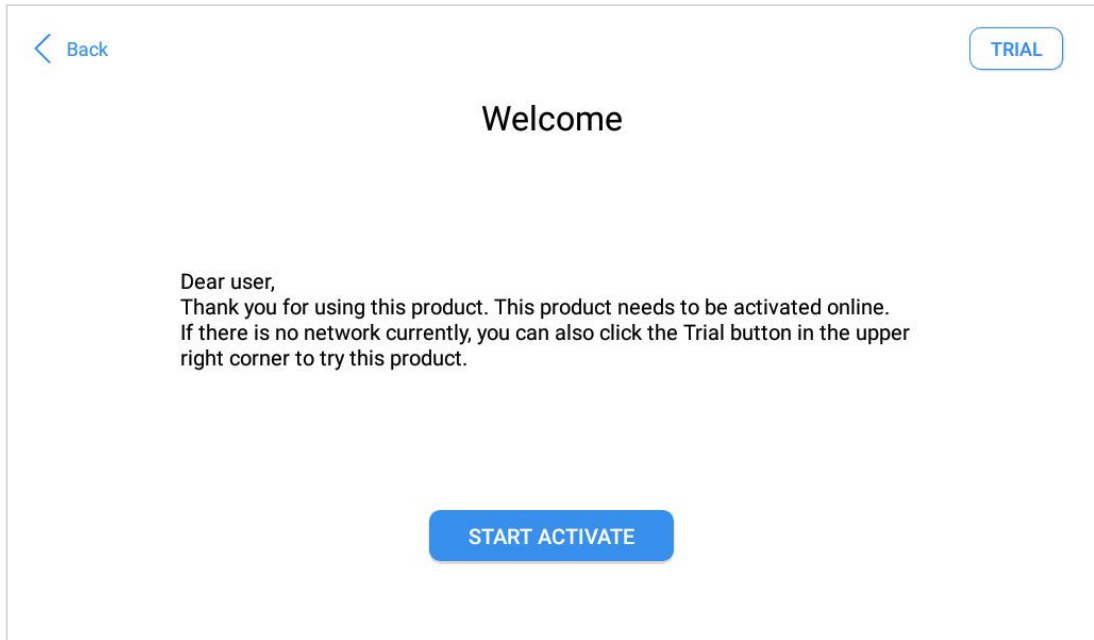

Fig 2-2

Click **Start Activate** to enter the activation page, as shown below:

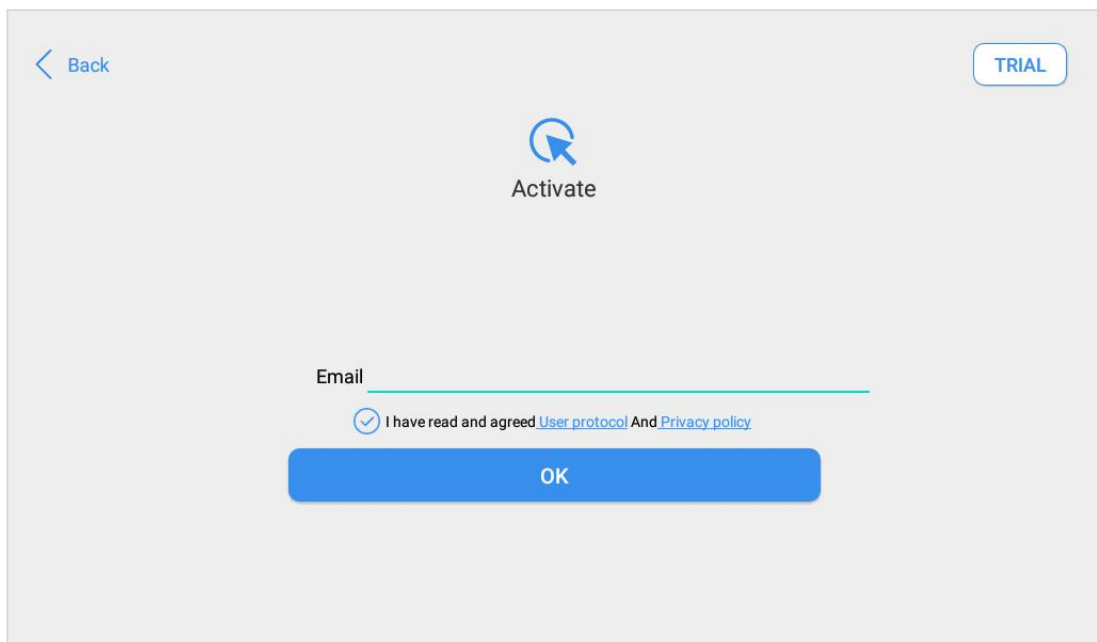

Fig 2-3

A pop-up window showing **Activation Success** indicates that you have completed the first boot setup, click **OK** to enter the diagnostic system and start using the device.

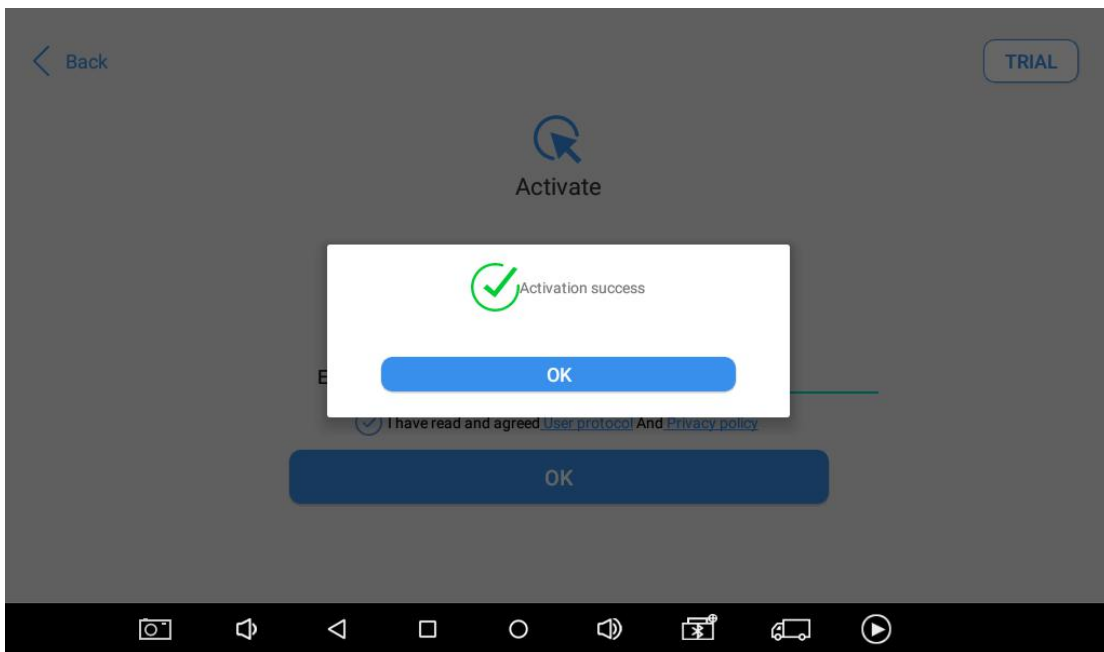



Fig 2-4

MAIN INTERFACE

OPERATION SYSTEM

As shown in the figure below, this interface is the main page of the operating system of the device. You can also return to this interface at any time by clicking **【】** on the bottom navigation bar.

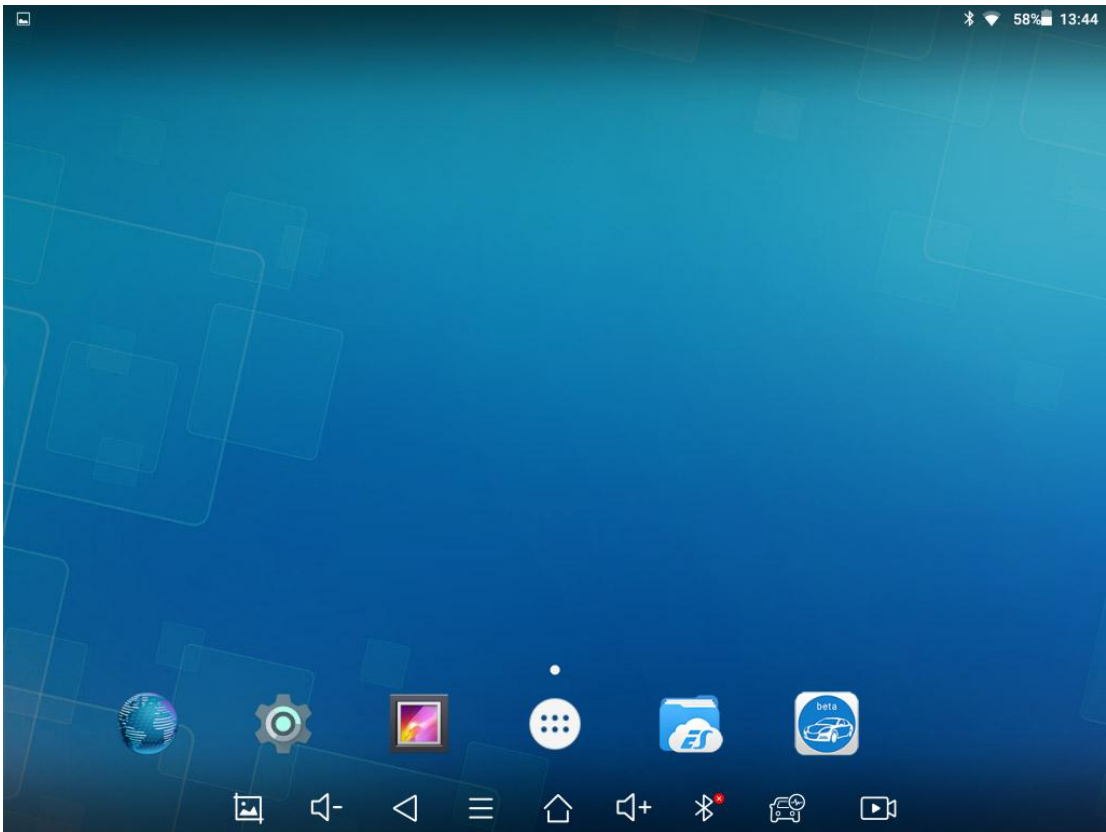







Fig 2-5

The icons on the right, from top to bottom, are browser, photo album, application square, file manager, system settings, as shown below:

Table 2-1

Items	Descriptions
	Browser
	Album
	Application Square
	File Explorer
	Settings for Android System
	D8 Smart Diagnosis System

- a) **Browser:** Click on the browser icon to enter the browser to view the official website of XTOOL or search for other information.
- b) **Gallery:** Click the **Gallery** icon to enter the album to quickly view the pictures or screenshots stored in the device. You can select the picture you need, click the share button on the upper

right, and send the picture to your mobile phone or PC via Bluetooth or USB connection

- c) **Application Square:** \You can remove or add Apps here.
- d) **ES File Explorer:** You can manage APP, music, files, pictures, etc. in the device in this function, and you can also use Local/Home/Cleaner to clean up files.

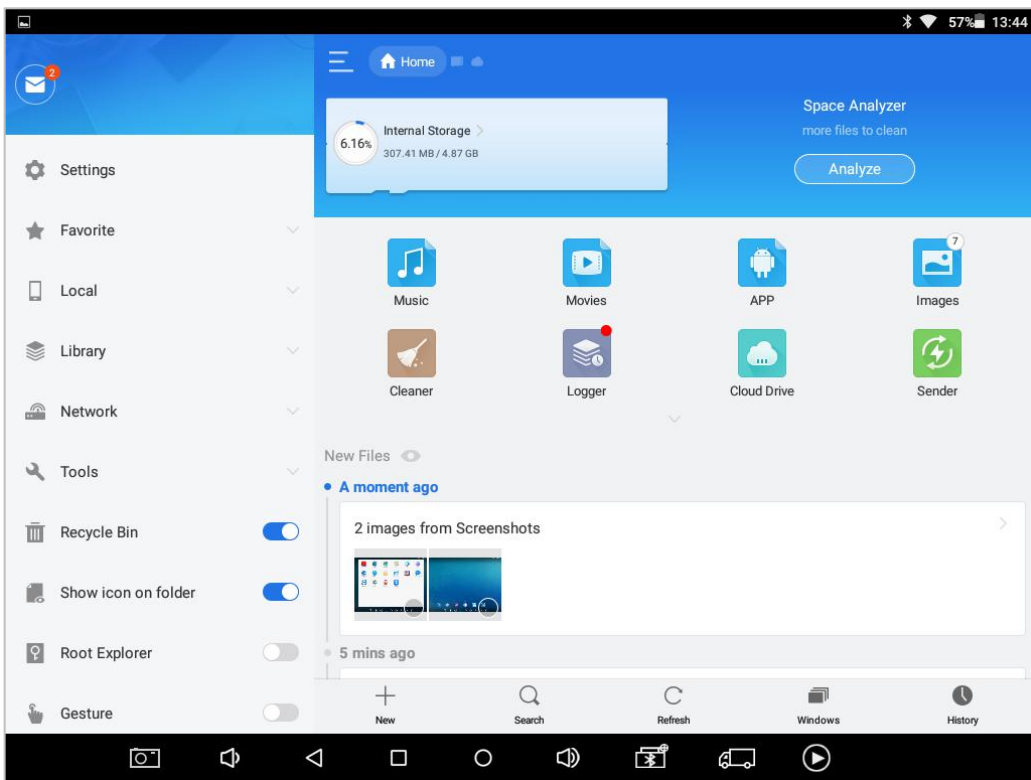

Fig 2-6

- e) **D8 Smart Diagnosis System:** The App allows you to diagnose your vehicle and offers a range of special maintenance services.

DIAGNOSIS SYSTEM ENTRANCE

Once activated, you will automatically enter the diagnostic system with the following main screen. Tap on the diagnosis application button on the menu, the main interface will be shown as below:











Fig 2-7

The main interface is mainly composed of **Function Buttons** and **Navigation Buttons**. The touch screen navigation is menu-driven, and you can quickly access functions by clicking on the option title and answering the dialogue window. A detailed description of the menu structure can be found in the next section **Function Buttons**.

FUNCTION BUTTONS

The following table briefly describes each function button







Table 2-2

Item	Description
	Quickly access to the vehicle system to identify the vehicle VIN code
	Enter to select a vehicle
	Includes special functions for car diagnosis
	You can view the vehicle diagnostic report
	In case of failure, you can control the diagnostic equipment remotely
	Users can upgrade the upgradeable software with one click
	Users can set the language, unit, Bluetooth, repair shop information, also can view information about this software
	Users can view extended functions such as XTOOL Cloud here

NAVIGATION BUTTONS

Instructions for operating the navigation bar buttons at the bottom of the screen, as described in the table below:

Table 2-3

Items	Descriptions
	Back to the previous interface
	Back to the main interface of the Android system
	Shows recently used applications
	Press for screenshot
	Increase volume
	Click here to return to the diagnostic vehicle models interface
	Decrease volume

NOTIFICATION BAR

Slide down to open the notification bar. Users can adjust the brightness of the screen when they need it, and they can also connect to Wi-Fi and so on.

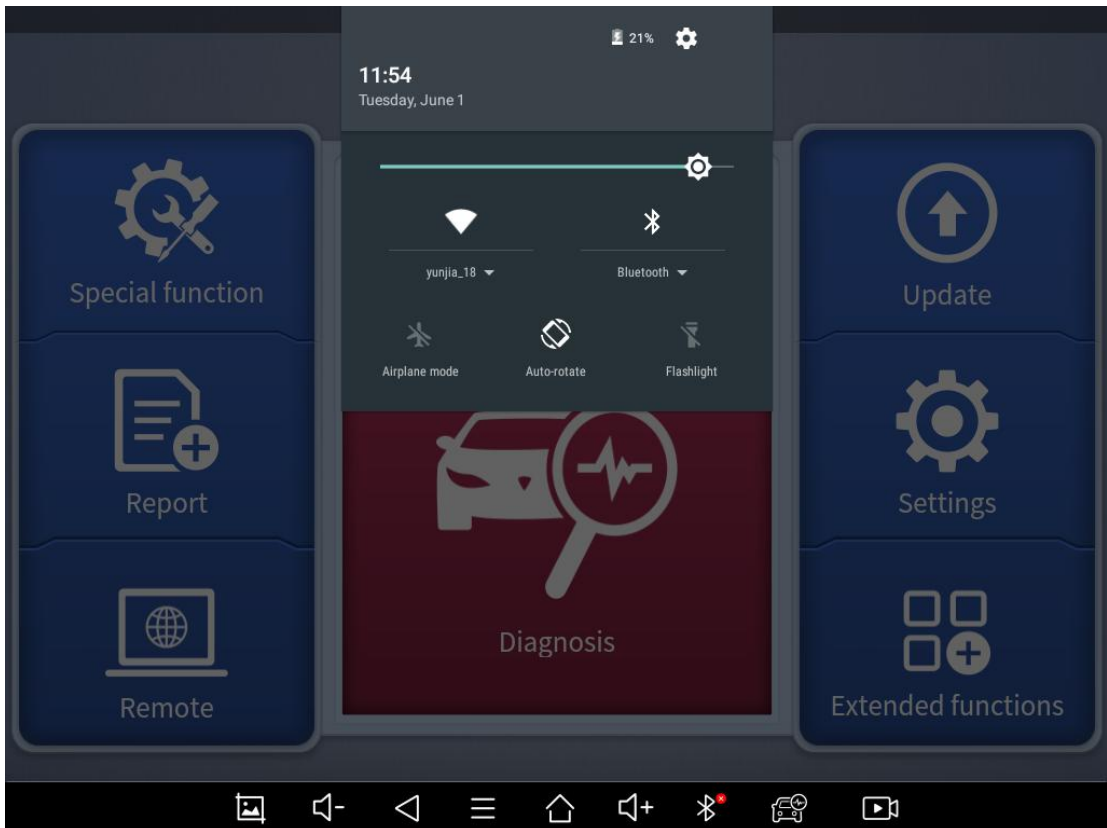

Fig 2-8

DELETE SOFTWARE

Long-press the unwanted software until it has been selected, then click the **Delete** button shown on the upper part of the screen. And you can select and delete multiple software at once.

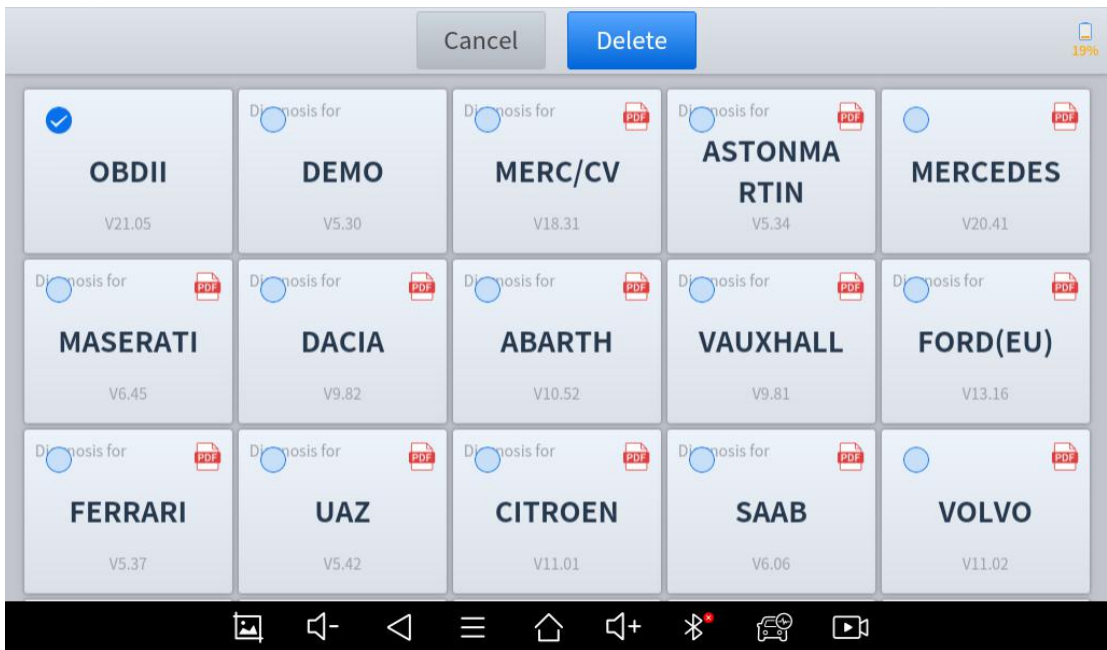

Fig 2-9

FACTORY RESET

When you choose to restore factory settings in the OS system, the device will automatically restart and enter the factory mode to pull the software. You can select the language in the following interface.

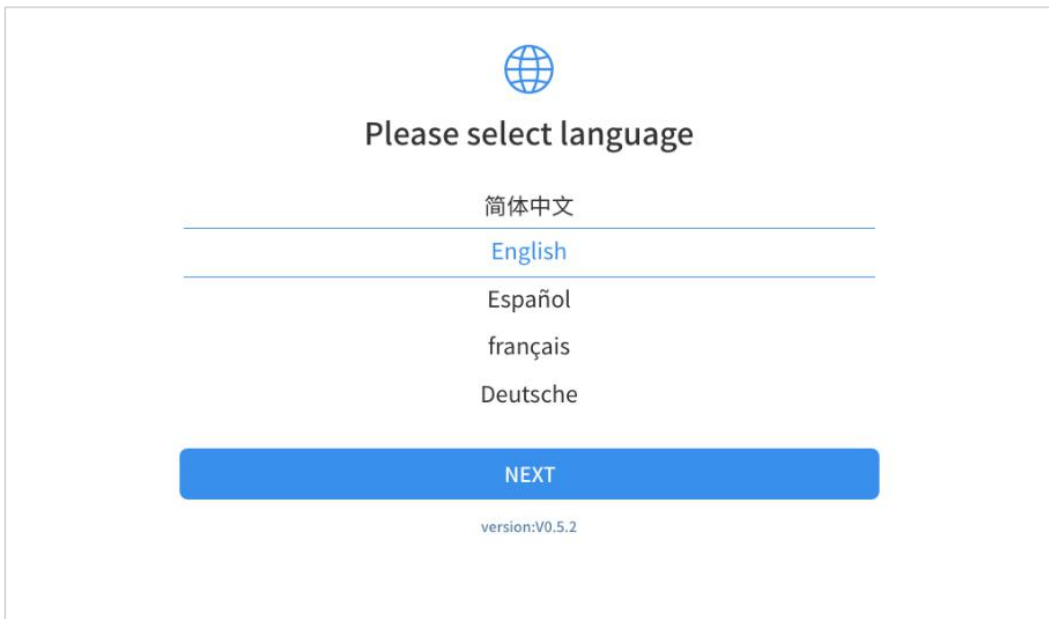

Fig 2-10

After selecting the system language, click **Next** to enter the Wi-Fi connection page, as shown below:

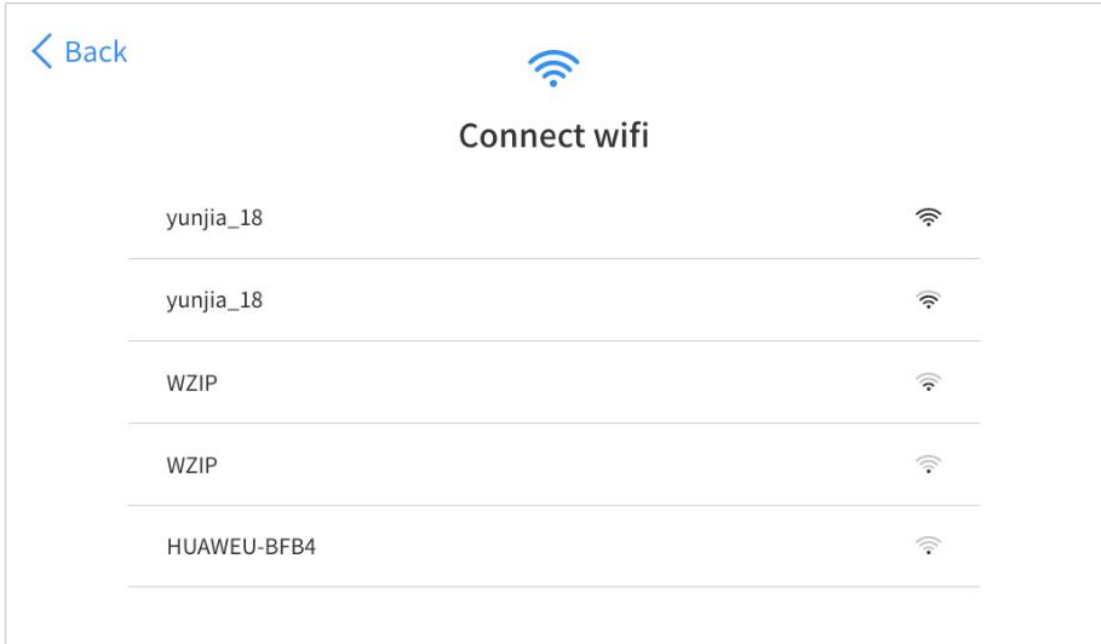

Fig 2-11

Select a network to connect to on the Wi-Fi connection page. After successful network connection, the automatic system will jump to **Factory mode** to download the software:

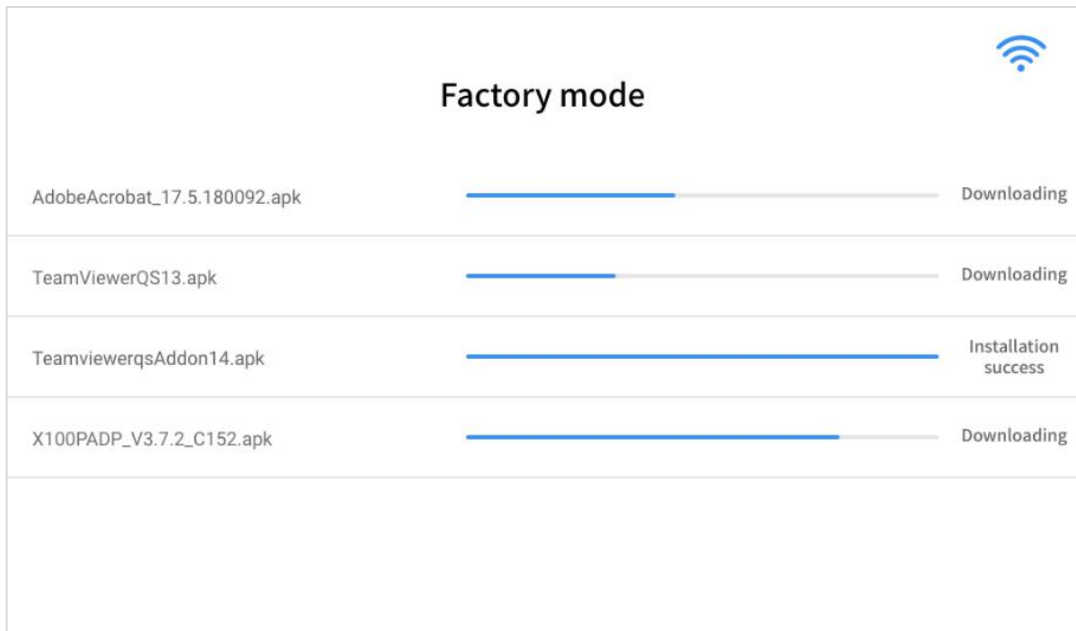

Fig 2-12

3 UPDATE

After activating the device, please update the software in "**Update**" first. The device will pull all currently supported software packages, and you can download them as needed. ALL software updates directly via the Internet. To access the update application, open the diagnosis application and click UPDATE, shown as below:



Fig 3-1

***Note**

- a) After contacting your dealer to change the language configuration, you need to download all the software packages on the device again.

4 DIAGNOSIS

The diagnostic application can read ECU information, read and clear DTC and check living data and freeze frames. The diagnosis application can access the electronic control unit (ECU) of various vehicle control systems, including the engine, transmission, anti-lock braking system (ABS), airbag system (SRS), and perform kinds of actuation tests.

VEHICLE CONNECTION

The diagnosis operation needs to connect the D8 smart diagnosis system to a vehicle first so that the tablet can establish correct vehicle communication. Please perform the following steps:

- 1 Turn on the tablet;
- 2 Connect cables and tablet in the following order: ①→②→③→④;
- 3 Switch on the ignition and tap on the Diagnosis application to test vehicles.

Since the display tablet and the VCI box are integrated, to communicate with the vehicle, the OBD II -16 connector must be connected to the main test cable, and the vehicle data connector should be inserted into the DLC usually located under the vehicle dashboard. The OBDII-16 adapter should be connected to the

vehicle, and the main test line should be connected to the OBDII-16 adapter and the tablet

The connection method is shown in the figure below:

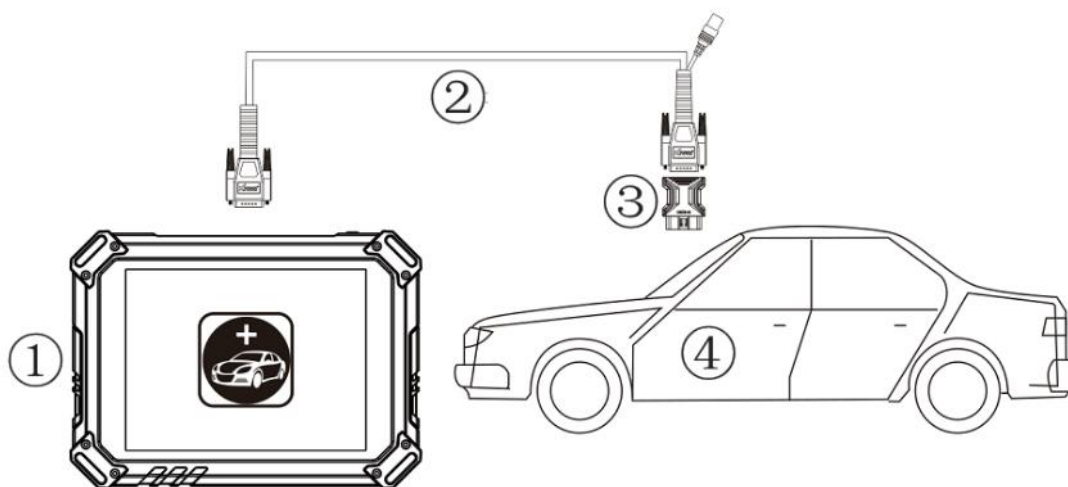

Fig 4-1

- ① Tablet
- ② Main Test Cable
- ③ OBDII-16 Connector
- ④ Vehicle

***Caution:** Please make sure all the cables are connected tightly; The vehicle's DLC is not always located under the dash; for the location of the DLC, please refer to the vehicle's user manual

DIAGNOSIS

After the tablet device is properly connected to the vehicle, you could start the vehicle diagnosis.

VEHICLE SELECTION

The D8 intelligent diagnosis system supports the following 4 ways to access the vehicle diagnosis system.

- AUTO SCAN
- SCAN CODE
- MANUAL ENTER
- SELECT VEHICLE BY AREA

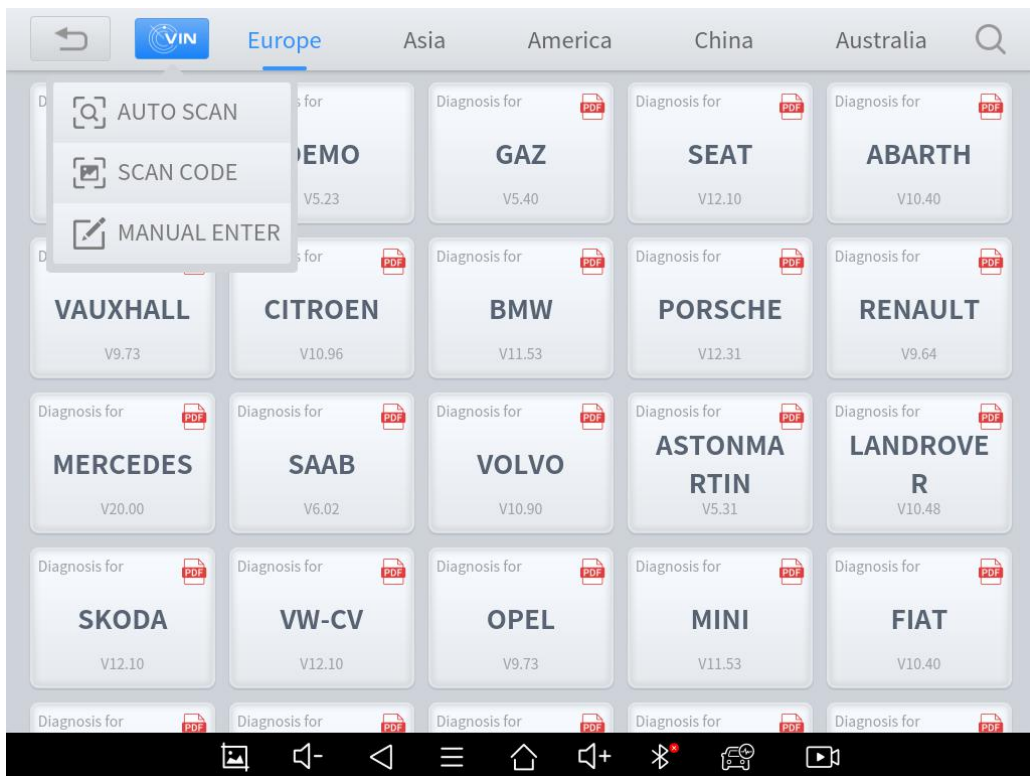

Fig 4-1

Click the VIN button in the upper left corner, you can choose to enter the vehicle diagnosis through the first 3 ways of **AUTO SCAN/SCAN CODE/MANUAL ENTER**.

- **AUTO SCAN:** It supports automatic reading of vehicle VIN code.

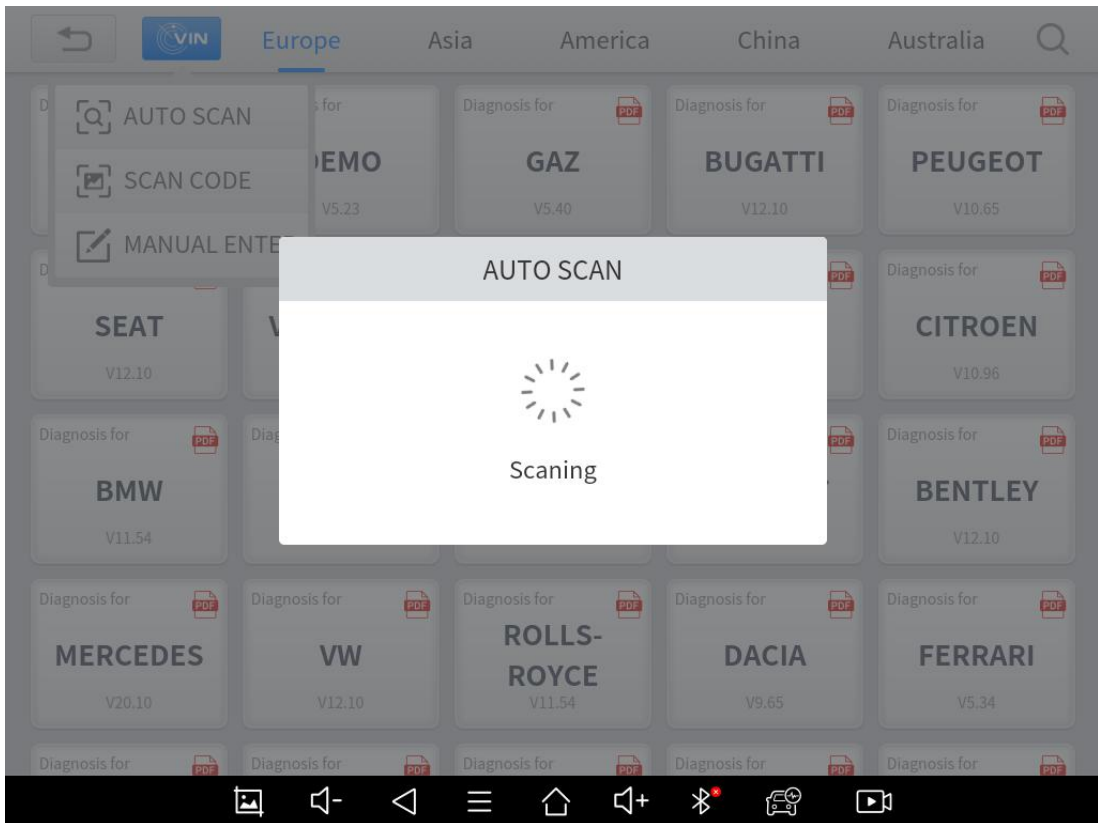

Fig 4-2

***Note**

- a) You also can tap on the button **"AUTO SCAN"** on the diagnosis system entrance to use this function.
- b) Please make sure that the car and the device are well connected before using this function.

- **SCAN CODE:** It supports scanning the bar code on the vehicle nameplate through the camera to automatically read the VIN code.

***Note**

- a) When using this function, please make sure that the light is sufficient and the bar code is not obstructed;
- b) Please make sure the wireless network environment is stable.

- **MANUAL ENTER:** It supports manual input of car VIN code. When entering the VIN code manually, make sure that the 17 characters entered are correct to avoid reading failure.

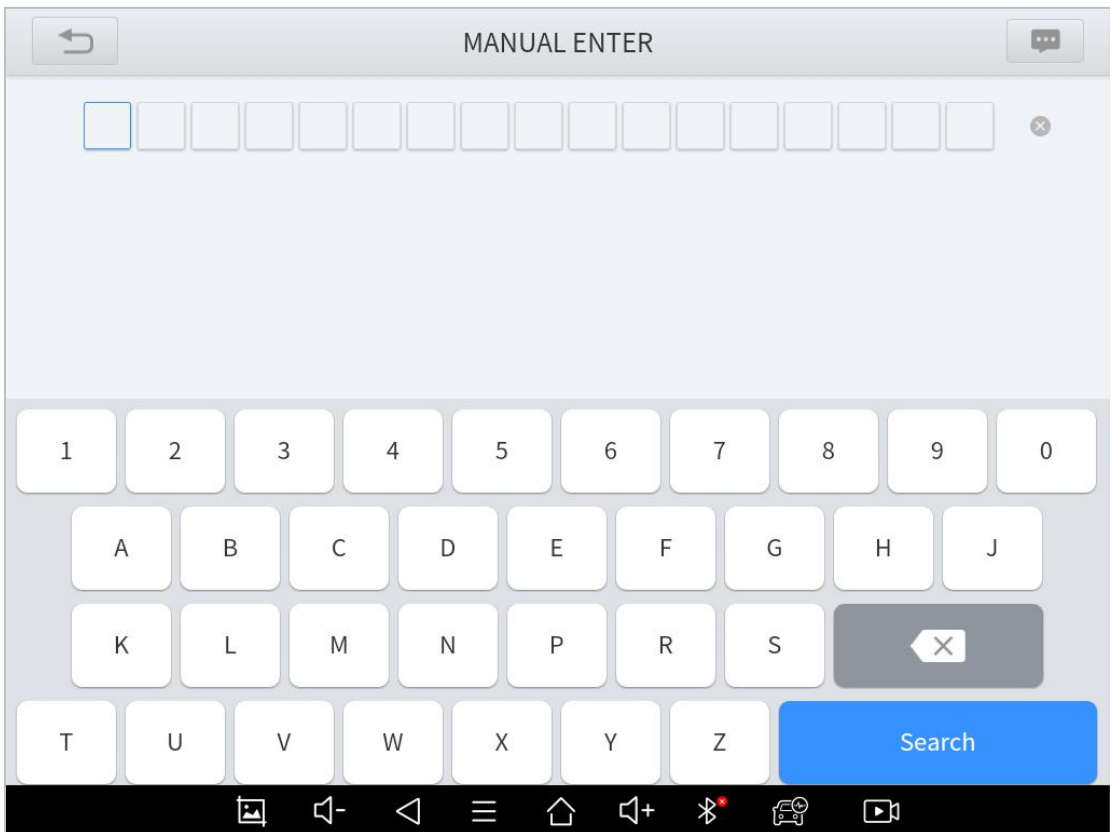

Fig 4-3

Note: This function supports historical VIN codes

SELECT VEHICLE BY AREA

In addition to the above 3 methods, you can also choose a car brand according to the region. You can select the vehicle model that needs to be diagnosed according to the area, as shown below:

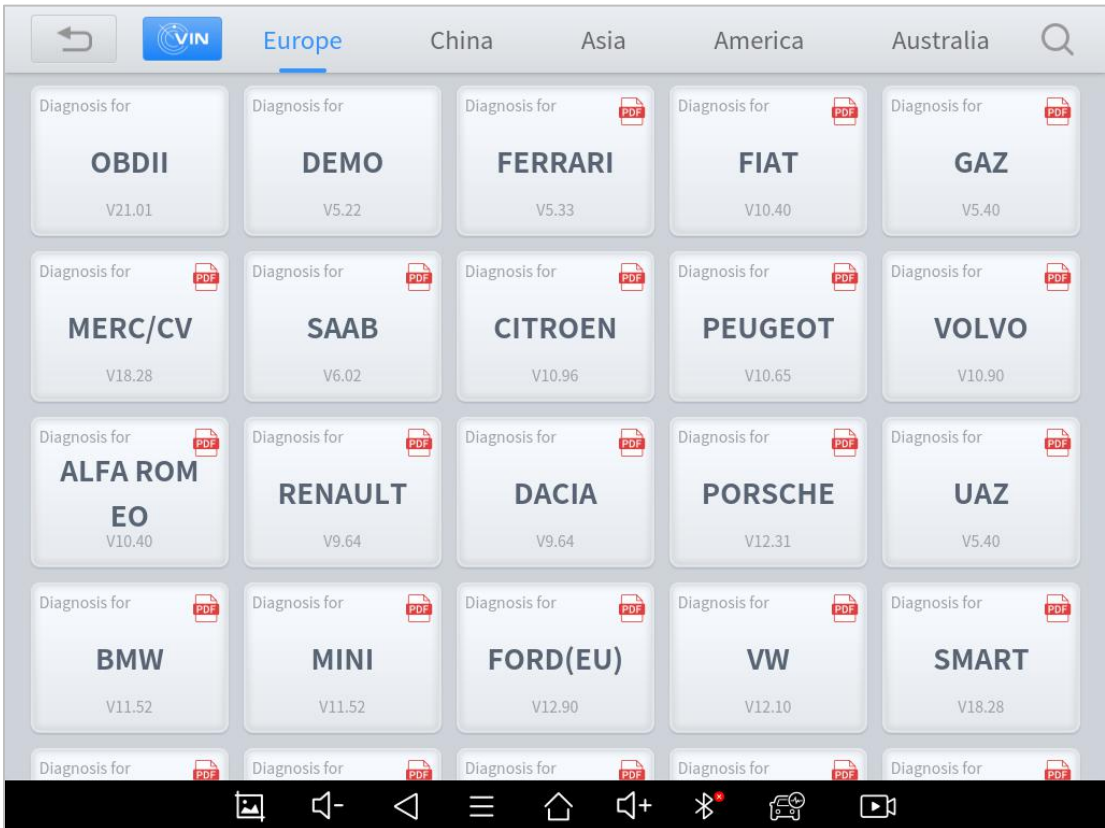

Fig 4-4

Some models provide multiple entry methods in the sub-menu, including **Automatic Detection**, **Manual Selection** and **System Selection**.



Fig 4-5

Automatic Detection will automatically identify the vehicle's VIN code, and then read the information of your target diagnostic object. If you choose "**Manual selection**", then you can continue to select the vehicle brand, year, and model of the vehicle in the sub-menu to diagnosis the vehicle. Enter "**System Selection**", you can also diagnose the vehicle according to the system according to your needs after selecting the model.

***Note**

- a) OBD II supports reading the common fault codes in the engine;
- b) DEMO, a demonstration program; Click this button to experience and learn the operation process of the diagnostic function;

- c) If you need to view the list of functions covered by the model, you can click the PDF icon at the top right of the model brand button.

BASIC FUNCTIONS

The diagnosis system supports 5 basic diagnosis functions, as follows:

- **Read ECU Information**
- **Read/Clear Trouble Code**
- **Read Live Data**
- **Actuation Test (Bi-Directional Control)**
- **Freeze Frame**

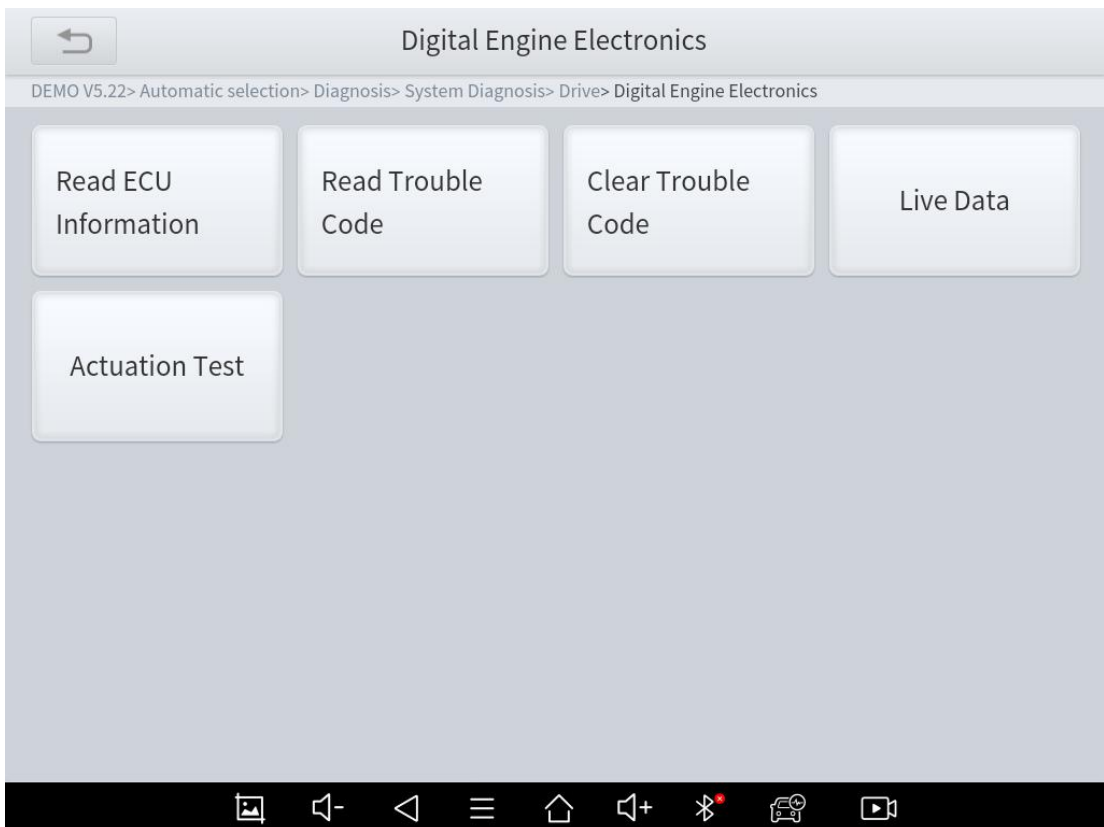

Fig 4-4

■ Read ECU Information

This function is to read ECU version information, which is the equivalent of "**System Identification**" or "**System information**" in some electronic control systems, all mean to read ECU related software and hardware versions, models and production date of diesel engine, part number, etc. It is convenient for us to make a record in the maintenance process, and it also makes data feedback and management easier.

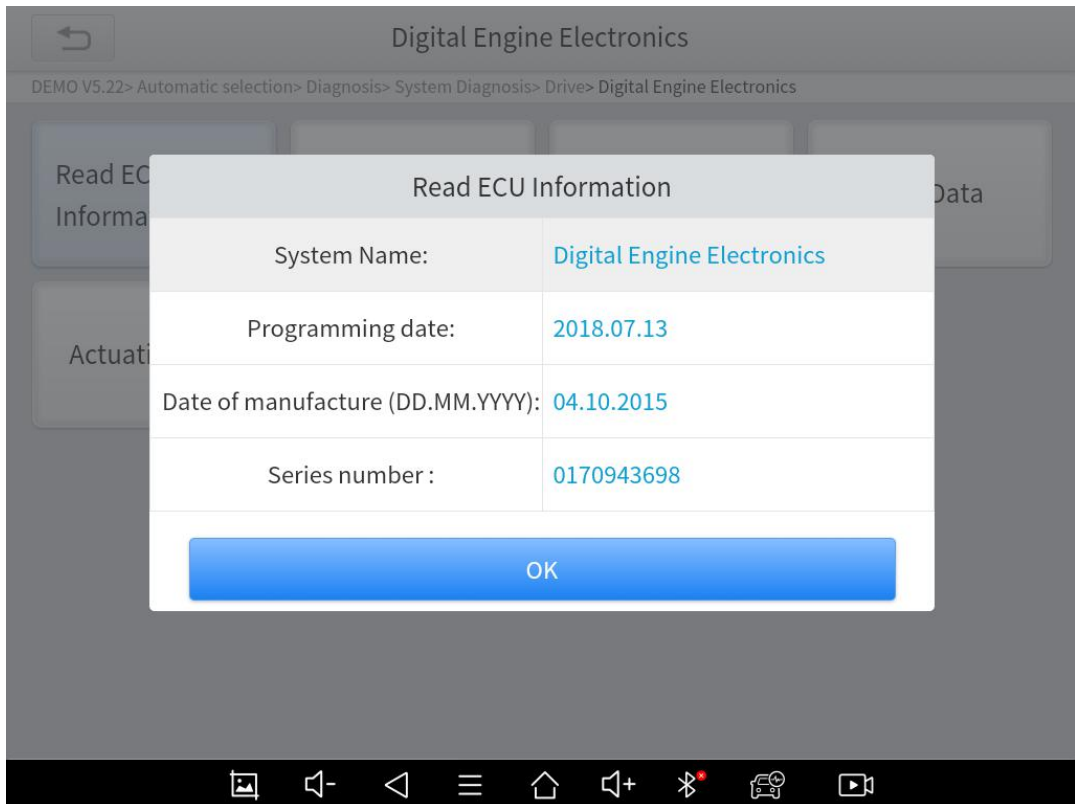

Fig 4-5

■ Read Trouble Code

Read trouble codes stored in ECU.

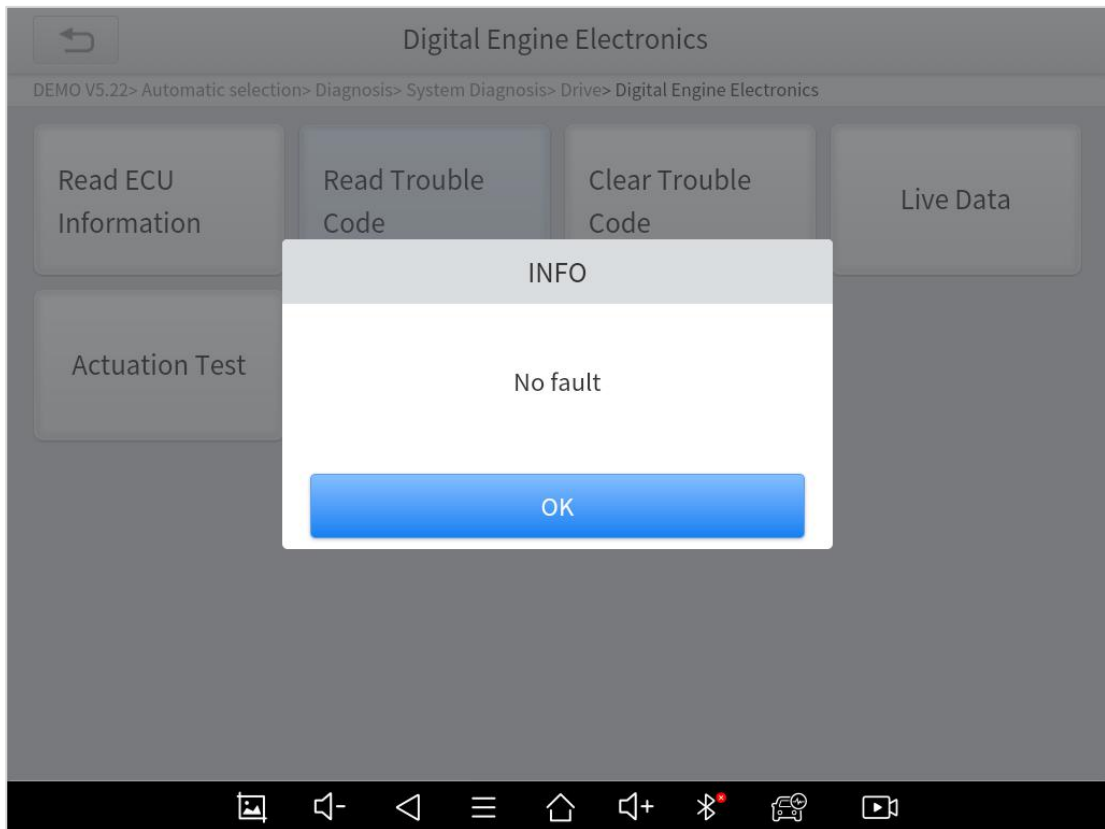

Fig 4-6

***Tip:** In the process of diagnosis, if the device shows “**System is OK**” or “**No Trouble Code**”, it means there is no related trouble code stored in ECU or some troubles are not under the control of ECU, most of these troubles are mechanical system troubles or executive circuit troubles, it is also possible that signal of the sensor may bias within limits, which can be judged in Live Data.

■ Clear Trouble Code

It allows clearing current and historical trouble codes memory in ECU, under the premise that all the troubles are eliminated.

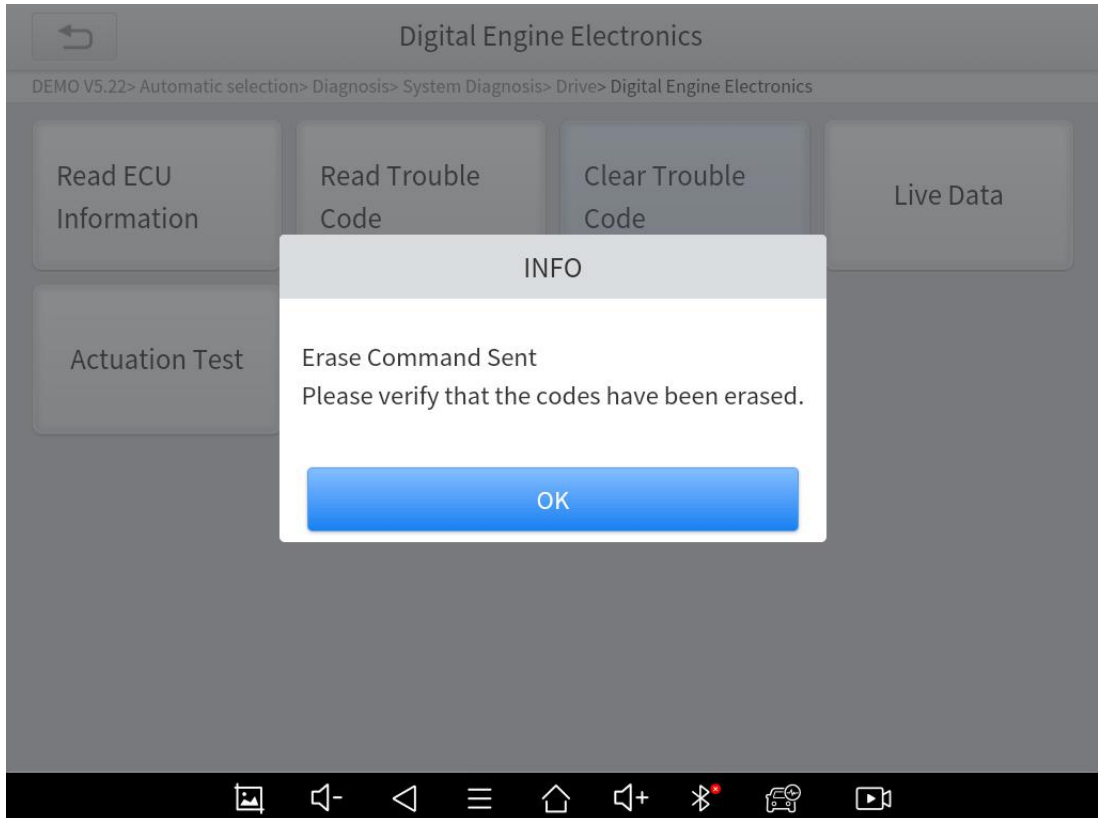
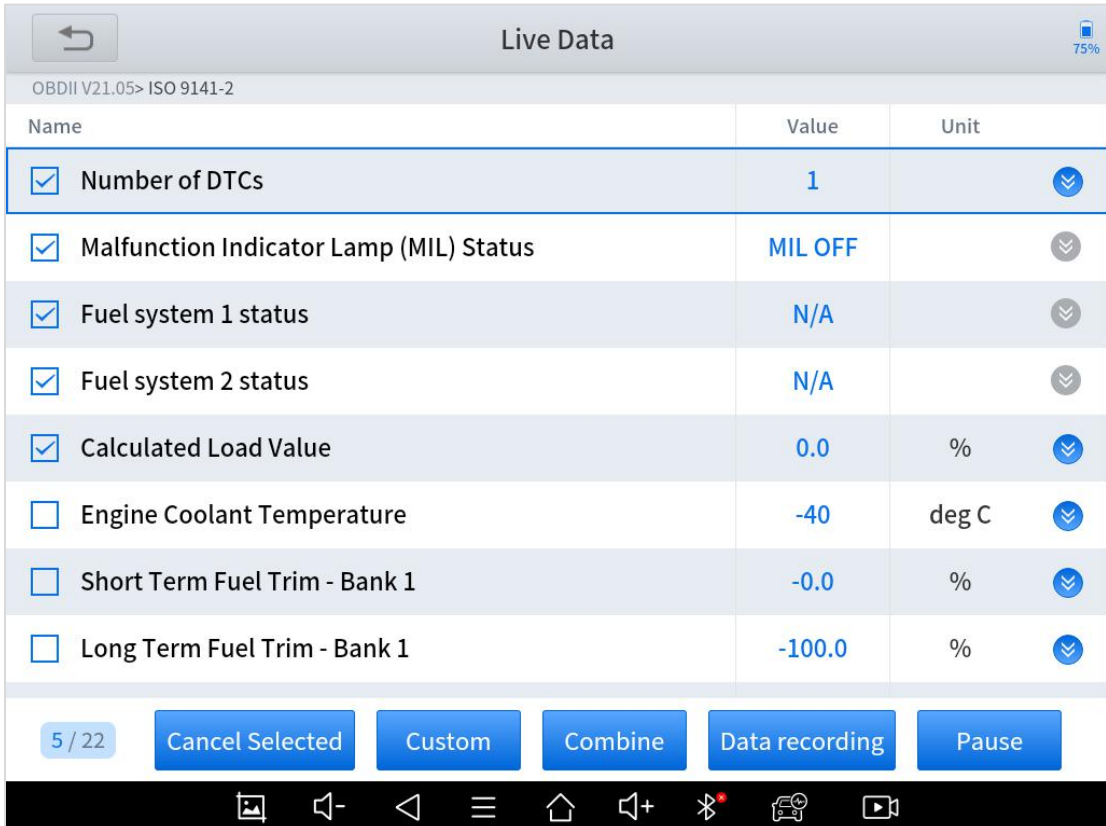

Fig 4-7

The trouble codes can't be erased without eliminating all the troubles, which will cause the diagnostic tool to always read the trouble code because the code will always be saved in ECU. Suggestion: users should better not clear trouble codes, we need to record the trouble details after reading the code, which is provided as a reference for maintenance. After dealing with troubles, there will be no trouble code when we re-read.

■ Read Live Data

That is to read the parameters of the running engine, such as oil pressure, temperature, engine speed, fuel oil temperature, coolant temperature, intake air temperature, etc. Based on these parameters, we can judge directly where the problem lies, which helps to narrow the scope of maintenance. For some vehicles, during their actual operation, the problems such as performance characteristics offset, sensitivity reduction, can be judged in live data.



Name	Value	Unit
<input checked="" type="checkbox"/> Number of DTCs	1	
<input checked="" type="checkbox"/> Malfunction Indicator Lamp (MIL) Status	MIL OFF	
<input checked="" type="checkbox"/> Fuel system 1 status	N/A	
<input checked="" type="checkbox"/> Fuel system 2 status	N/A	
<input checked="" type="checkbox"/> Calculated Load Value	0.0	%
<input type="checkbox"/> Engine Coolant Temperature	-40	deg C
<input type="checkbox"/> Short Term Fuel Trim - Bank 1	-0.0	%
<input type="checkbox"/> Long Term Fuel Trim - Bank 1	-100.0	%

5 / 22 Cancel Selected Custom Combine Data recording Pause

Fig 4-8

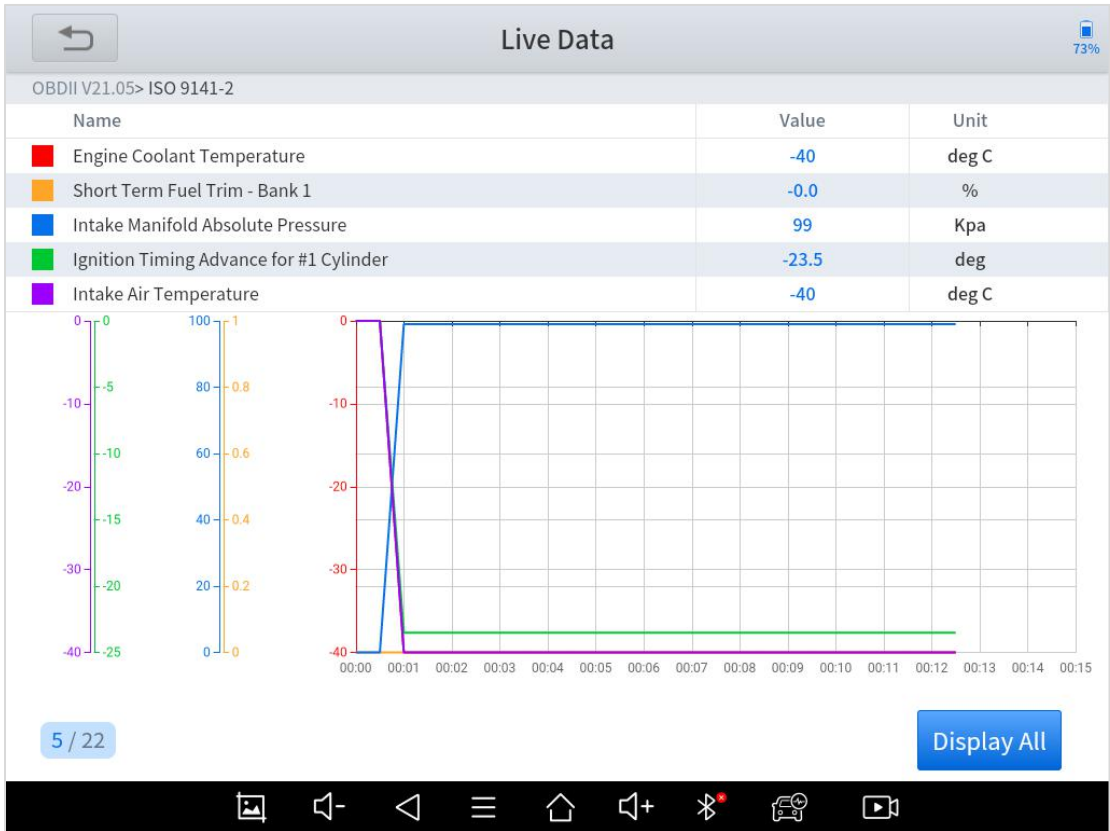
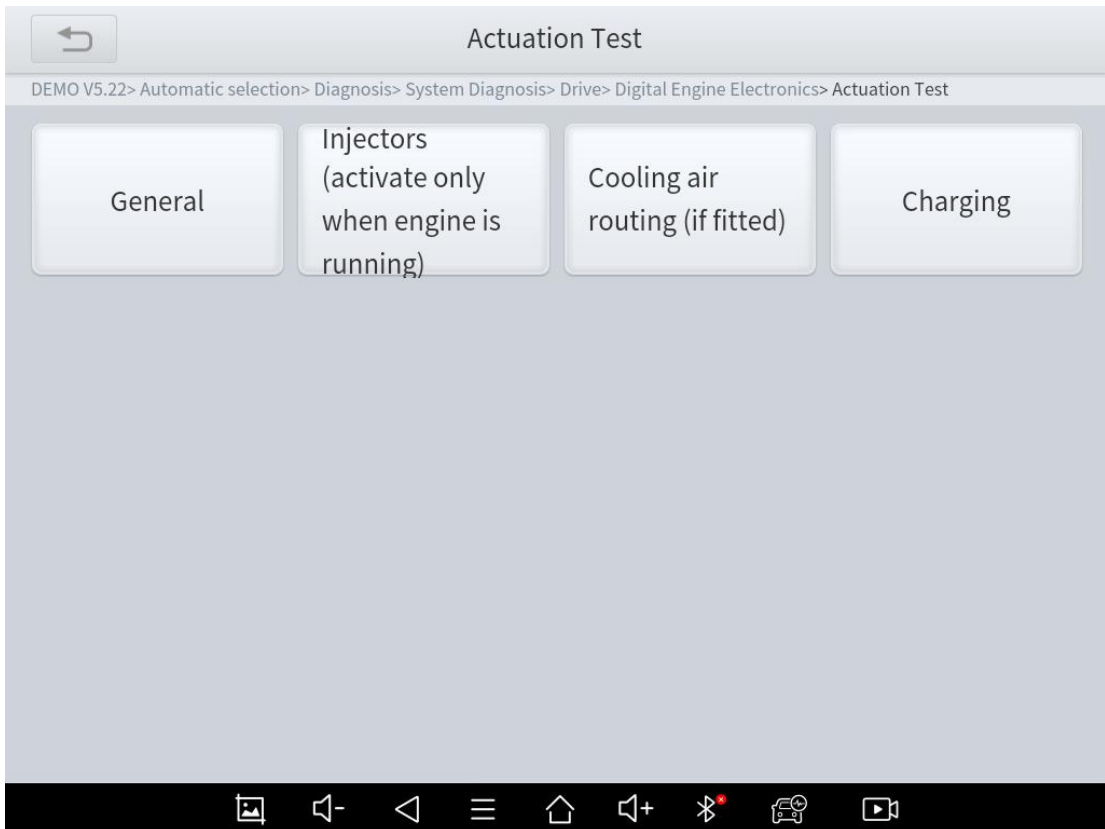

Fig 4-8

In the process of diagnosis, if the device shows “**System is OK**” or “**No Trouble Code**”, it means there is no related trouble code stored in ECU or some troubles are not under the control of ECU, most of these troubles are mechanical system troubles or executive circuit troubles, it is also possible that signal of the sensor may bias within limits, which can be judged in Live Data.

■ Actuation Test (Bi-Directional Control)

Actuation test, also known as bidirectional control, is a generic term used to describe sending and receiving information between one device and another.



The vehicle engineers responsible for designing computer control systems programmed them so a scan tool could request information or command a module to perform specific tests and functions. Some manufacturers refer to bidirectional controls as functional tests, actuator tests, inspection tests, system tests or the like. Reinitialization and reprogramming also can be included in the list of bidirectional controls.

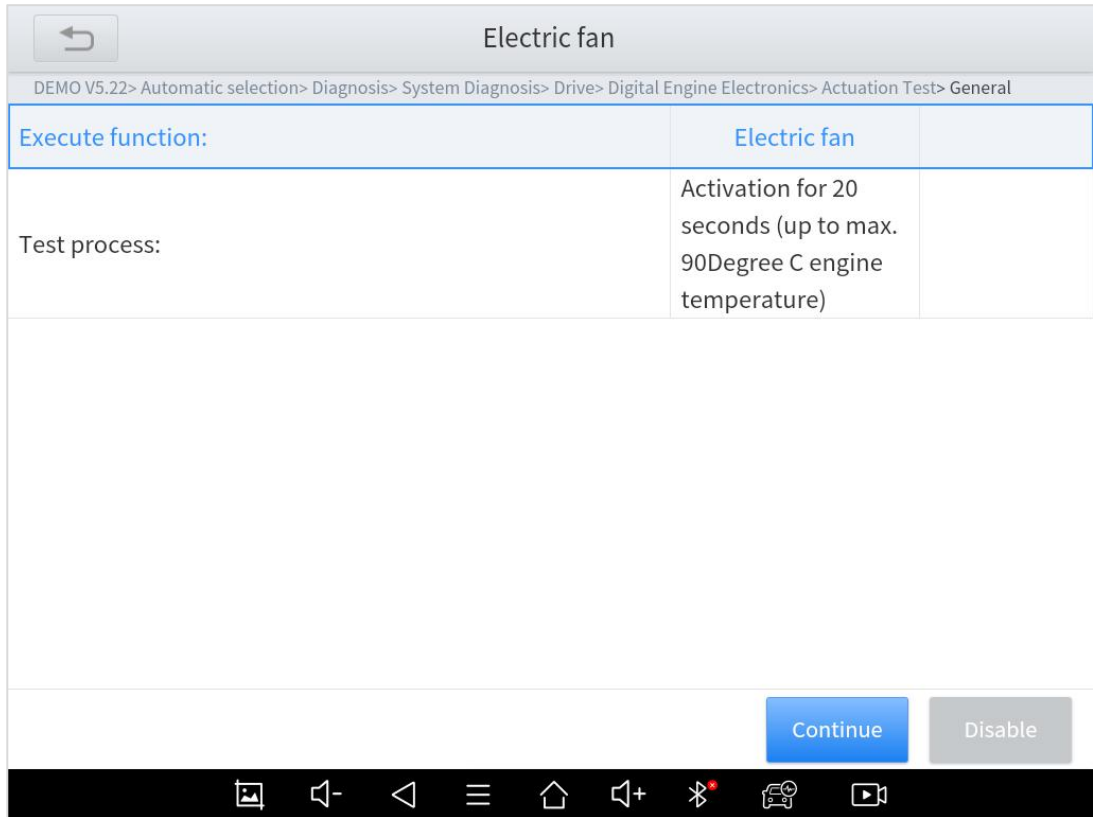
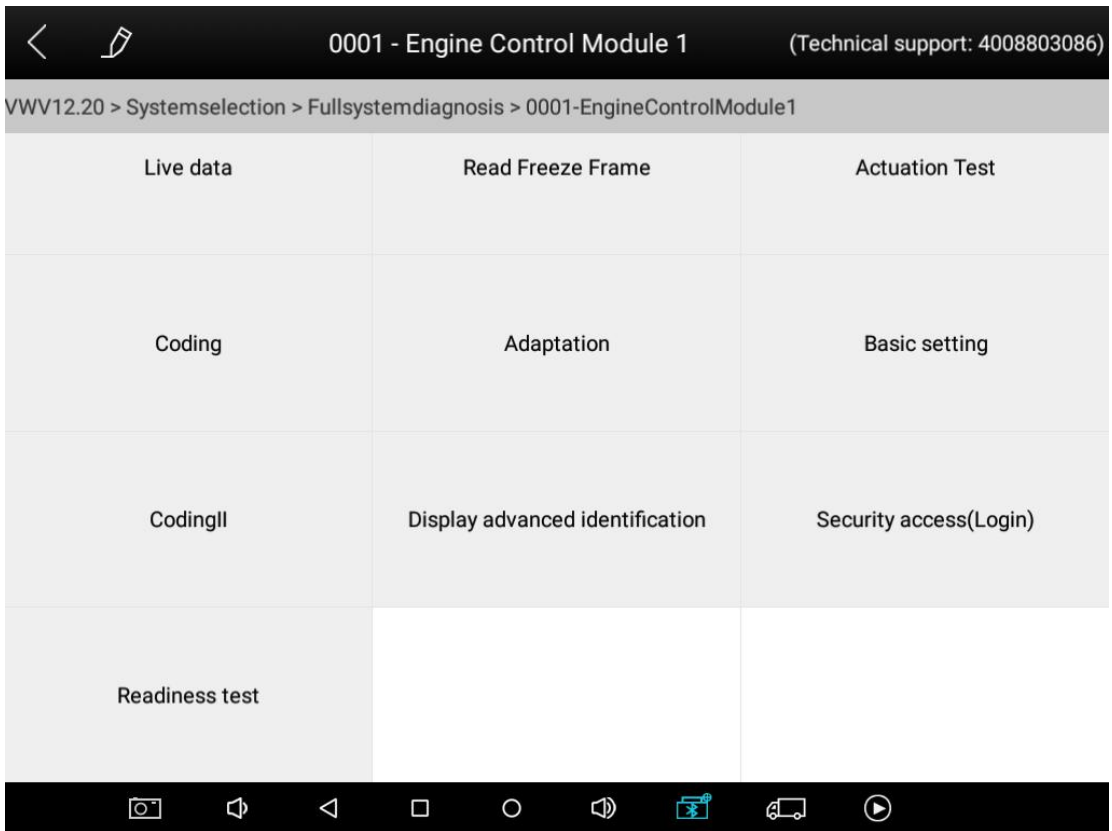

Fig 4-9

This function allows the device to send information to, and receive information from, vehicle control modules. For example, in the case of OBD II generic information Mode 1 (which relates to data parameters), the scan tool user initiates a request for information from the powertrain control module (PCM), and the PCM responds by sending the information back to the scan tool for display. Most enhanced scan tools also can actuate relays, injectors and coils, perform system tests, etc. Users could check the individual part to see what is working properly by actuation test.

■ **Freeze Frame**



When the signal of the sensor is abnormal, the ECU will save the data at that moment of failure to form a freeze-frame. It is usually used to analyze the reasons that may lead to car failures.

The living data items supported by vehicles of different brands are not the same, so the freeze frames displayed when diagnosing vehicles of different brands may also be different. Some vehicles do not have a freeze frame option, which means that this model may not support this feature.

5 SPECIAL FUNCTIONS

The D8 Smart Diagnosis System supports 23 commonly used special reset functions, allowing you to quickly access your vehicle system for various scheduled services, maintenance and reset performance, eliminating the need to reset after resolving common problems. This user manual lists some of the commonly used special reset services for your reference. The special functions interface is shown as below:

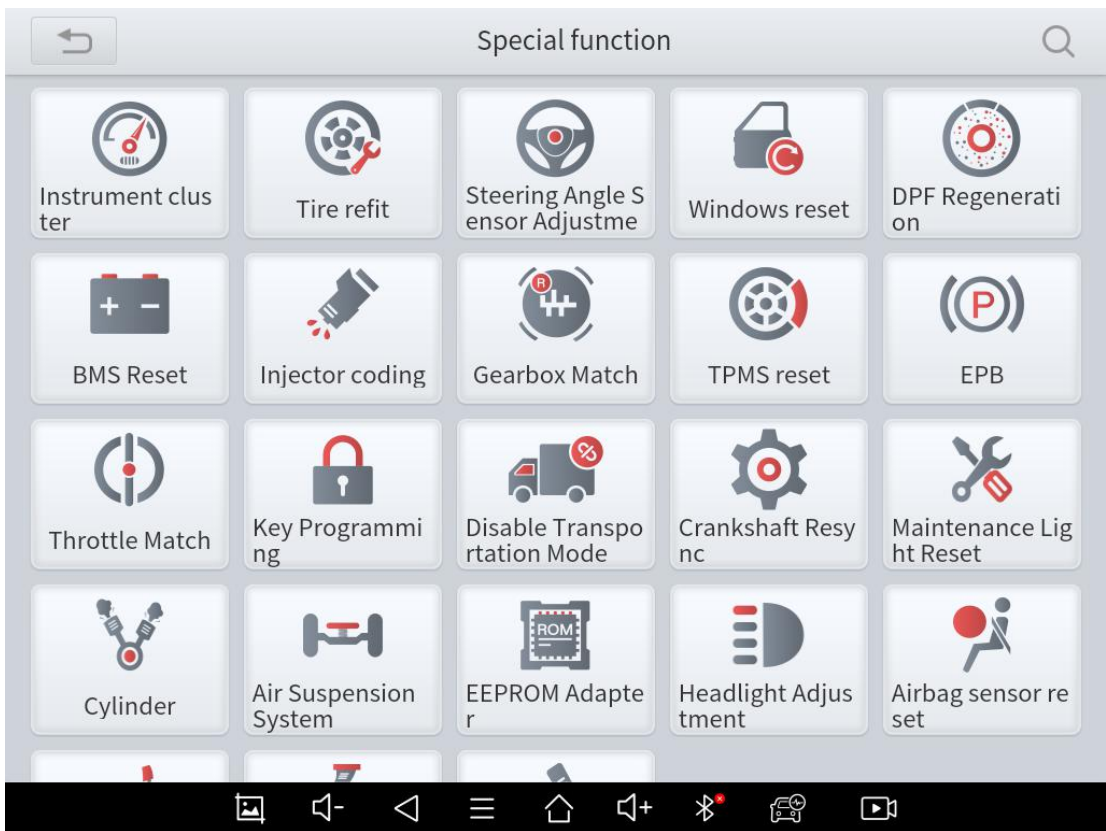

Fig 5-1

***Note:**

- a) Due to the limitation of screenshots, the special functions shown in this picture are not complete.
- b) All special functions supported by D8 are subject to the actual special functions displayed on the device.

OIL LIGHT RESET

Reset the Engine Oil Life System, which calculates the optimum oil life change interval based on the vehicle's driving conditions and climate. The oil life reminder must be reset each time the oil is changed so that the system can calculate when the next oil change is required.

This function allows you to perform a reset for the engine oil life system, which calculates an optimal oil life change interval depending on the vehicle driving conditions and climate.

This function can be performed in the following cases:

- If the service lamp is on, you must provide service for the car. After service, you need to reset the driving mileage or driving time so that the service lamp turns off and the system enables the new service cycle.
- After changing engine oil or electric appliances that monitor oil life, you need to reset the service lamp.

EPB

Electronic Parking Brake (EPB) System reset is a popular special function. You can use this function to reset the electronic parking brake system and brake pads, which also supports the brake pad replacement (retraction, release of the brake pump), G-sensor and body angle calibration. This function has multiple uses and can safely and effectively maintain the electronic brake system. These applications include deactivating and activating brake control systems, assisting in controlling brake fluid, opening and closing brake pads, and setting brakes after replacing brake discs or brake pads, etc.

1. If the brake pad wears the brake pad sense line, the brake pad sense line sends a signal sense line to the onboard tablet to replace the brake pad.

After replacing the brake pad, you must reset the brake pad. Otherwise, the car alarms.

2. Reset must be performed in the following cases:

- The brake pad and brake pad wear sensor are replaced.
- The brake pad indicator lamp is on.
- The brake pad sensor circuit is short, which is recovered.
- The servo motor is replaced.

SAS

Steering Angle Sensors (SAS) System Calibration permanently stores the current steering wheel position as the straight-ahead position in the SAS EEPROM. Therefore, the front wheels and the steering wheel must be set exactly to the straight-ahead position before calibration. In addition, the VIN is also read from the instrument cluster and stored permanently in the SAS EEPROM. On successful completion of calibration, the SAS fault memory is automatically cleared.

To reset the steering angle, first find the relative zero point position for the car to drive in a straight line. Taking this position as a reference, the ECU can calculate the accurate angle for left and right steering.

After replacing the steering angle position sensor, replacing steering mechanical parts (such as steering gearbox, steering column, end tie rod, steering knuckle), performing four-wheel alignment, or recovering the car body, you must reset the steering angle.

DPF

The Diesel Particle Filter (DPF) function manages DPF regeneration, DPF component replacement teach-in and DPF teach-in after replacing the engine control unit.

The ECM monitors driving style and selects a suitable time to employ regeneration. Cars driven a lot at idling speed and low load will attempt to regenerate earlier than cars driven more with higher load and speed. For regeneration to take place, a prolonged high exhaust temperature must be obtained.

In the event of the car being driven in such a way that regeneration is not possible, i.e., frequent short journeys, a diagnostic trouble code will eventually be registered in addition to the DPF light and “Check Engine” indicators displaying. A service regeneration can be requested in the workshop using the diagnostic tool.

DPF regeneration is used to clear PM (Particulate Matter) from the DPF filter through continuous combustion oxidation mode (such as high-temperature heating combustion, fuel additive or catalyst reduce PM ignition combustion) to stabilize the filter performance.

DPF regeneration may be performed in the following cases:

- The exhaust back pressure sensor is replaced.
- The PM trap is removed or replaced.
- The fuel additive nozzle is removed or replaced.
- The catalytic oxidizer is removed or replaced.
- The DPF regeneration MIL is on and maintenance is performed.
- The DPF regeneration control module is replaced.

BMS RESET

The Battery Management System (BMS) allows the scan tool to evaluate the battery charge state, monitor the close-circuit current, register the battery replacement, and activate the rest state of the vehicle.

This function enables you to perform a resetting operation on the monitoring unit of the vehicle battery, in which the original low battery fault information will be cleared and battery matching will be done.

Battery matching must be performed in the following cases:

- The main battery is replaced. Battery matching must be performed to clear original low battery information and prevent the related control module from detecting false information. If the related control module detects false information, it will invalidate some electric auxiliary functions, such as automatic start & stop function, sunroof without one-key trigger function, power window without automatic function.
- Battery monitoring sensor. Battery matching is performed to re-match the control module and monitoring sensor to detect battery power usage more accurately, which can avoid an error message displayed on the instrument panel.

THROTTLE

Throttle Position Sensor (TPS) Match, this function enables you to make initial settings to throttle actuators and returns the “learned” values stored on ECU to the default state. Doing so can accurately control the actions of regulating throttle (or idle engine) to adjust the amount of air intake.

TPMS RESET

Tire Pressure Monitor System (TPMS) Reset allows you to quickly look up the tire sensor IDs from the vehicle ECU, as well as to perform TPMS replacement and reset procedures after tire sensors are replaced.

This function allows you to quickly lookup the tire sensor IDs from the vehicle’s ECU, as well as to perform TPMS replacement and sensor tests.

- After the tire pressure MIL turns on and maintenance is performed, the tire pressure resetting function must be performed to reset tire pressure and turn off the tire pressure MIL.
- Tire pressure resetting must be performed after maintenance is performed in the following cases: tire pressure is too low, tire leaks, tire pressure monitoring device is replaced or installed,

the tire is replaced, the tire pressure sensor is damaged, and tire is replaced for the car with tire pressure monitoring function.

ABS BLEEDING

Anti-lock Braking System (ABS) Bleeding allows you to perform various bi-directional tests to check the operating conditions of ABS.

1. When the ABS contains air, the ABS bleeding function must be performed to bleed the brake system to restore ABS brake sensitivity.
2. If the ABS tablet, ABS pump, brake master cylinder, brake cylinder, brake line, or brake fluid is replaced, the ABS bleeding function must be performed to bleed the ABS.
3. After the oil in the brake oil tank is seriously insufficient or the brake fluid is replaced, ABS Bleeding is also required

***Note**

- a) When performing ABS Bleeding, it is necessary to unscrew the exhaust screw of the ABS pump.
- b) After completing the tire pressure sensor learning, it takes a while for the fault light to go out.
- c) Tire pressure imbalance will also cause the tire pressure light to light up.

INJECTOR CODING

This function can write the identification code of the fuel injector into the ECU so that the ECU can recognize and work normally.

Write injector actual code or rewrite code in the ECU to the injector code of the corresponding cylinder to more accurately control or correct cylinder injection quantity.

After the ECU or injector is replaced, the injector code of each cylinder must be confirmed or re-coded so that the cylinder can better identify injectors to accurately control fuel injection.

***Note**

- a) After cleaning, generally there is no need to do the coding matching function.
- b) The identification of the fuel injector includes its working accuracy value and type value. When replacing it, you need to find the corresponding model for replacement.
- c) At present, mainstream cars support injector coding function

GEARBOX MATCH

After changing the gearbox or changing the gearbox ECU, you need to use the gearbox matching function to re-match the engine and the gearbox.

***Cautions!**

Before resetting the gearbox, please check the gearbox control unit to ensure that there is no fault code. If there is a fault code, the gearbox memory function cannot be reset. Please road test after reset.

KEY PROGRAMMING

An immobilizer is an anti-theft mechanism that prevents a vehicle's engine from starting unless the correct ignition key or other device

is present. Most new vehicles have an immobilizer as standard equipment. An important advantage of this system is that it doesn't require the car owner to activate it since it operates automatically. An immobilizer is considered as providing much more effective anti-theft protection than an audible alarm alone.

As an anti-theft device, an immobilizer disables one of the systems needed to start a car's engine, usually the ignition or the fuel supply. This is accomplished by radio frequency identification between a transponder in the ignition key and a device called a radio frequency reader in the steering column. When the key is placed in the ignition, the transponder sends a signal with a unique identification code to the reader, which relays it to a receiver in the vehicle's tablet control module. If the code is correct, the tablet allows the fuel supply and ignition systems to operate and start the car. If the code is incorrect or absent, the tablet disables the system, and the car will be unable to start until the correct key is placed in the ignition.

To prevent the car from being used by unauthorized keys, the anti-theft key matching function must be performed so that the immobilizer control system on the car identifies and authorizes remote control keys to normally use the car.

When the ignition switch key, ignition switch, combined instrument panel, ECU, BCM, or remote-control battery is replaced, anti-theft key matching must be performed.

The Key Programming service can disable a lost vehicle key and program the replacement key fob. One or more replacement key fobs can be programmed.

***Note**

- a) Some models need to be used with EEPROM adapter for IMMO service.
- b) The EEPROM adapter is not included in this product.
- c) Please purchase it separately if you need it.

SUSPENSION

This function can adjust the height of the vehicle body. When replacing the body height sensor in the air suspension system, or control module or when the vehicle level is incorrect, you need to perform this function to adjust the body height sensor for level calibration.

The air suspension system reset function enables the tablet ECU to match the current air suspension system information, thereby ensuring the normal damping effect of the vehicle when driving.

Application scenarios:

- The shock absorber is not the same height due to air leakage, maintenance, replacement, etc.;
- After replacing the air pump assembly;
- After replacing the electronic control module.

WINDOWS INITIALIZATION

This function is to match the windows to restore the initial memory of the ECU and restore the automatic raising and lowering functions of the power window. Usually, when the vehicle window fails or after replacing the window glass, we need to use this function to initialize the car window.

SEAT CALIBRATION

This function is suitable for the matching of replacement and maintenance seats with memory functions. After the seat fails or is replaced or repaired, it is generally necessary to use this function to match the seat.

***Note**

Needed for cars with seats with memory function, general gasoline cars don't need.

HEADLIGHT

This function is used to initialize the adaptive headlight system. It refers to the adaptive front lighting system (when using bi-xenon headlights at night), it can be rotated to the sides, pressing the button means that they remain direct, and do not turn when you turn. After replacing the headlights, the adaptive headlight system needs to be matched.

ECU CONFIGURATION

When a car with a high-level configuration and a car with a low-level configuration share the same ECU, or you need to change or add some features unique to the high-end vehicles, you can use this function to support the activation of the hidden functions of the car (except those that are not supported by the hardware). Different hidden functions may require different operation steps, please be sure to operate under the guidance.

Cautions!

- The functions that the original ECU must support can be flashed out.
- Brushing to hide will not destroy the ECU system layer, but only open and close some functions.
- Most of them can be re-flashed multiple times.

Support cars:

Volkswagen, Toyota, BMW, Ford, Mazda

***A/F RESET**

This function is applied to set or learn Air/Fuel ratio parameters.

***STOP/START RESET**

This function is used to open or close the automatic start-stop function via setting the hidden function in ECU (provided that the vehicle has a hidden function and is supported by hardware).

AIRBAG RESET

Supplemental Restraint System (SRS) Reset allows you to reset the airbag data to clear the airbag collision fault indicator. Generally, SRS reset is required after airbag replacement

INSTRUMENT CLUSTER

This function allows you to copy, write or rewrite the kilometres in the odometer chip by using the car diagnostic tablet and data cable so that the odometer can display the actual mileage.

*Some models need to be used with an EEPROM adapter for ODO reset. The EEPROM adapter is not included in this product. Please purchase it separately if you need to use it.

***LANGUAGE CHANGE**

This function is used to change the system language of the vehicle central control panel.

TRANSPORT MODE

In order to reduce power consumption, the following functions may be disabled, including limiting the vehicle speed, not waking up the door opening network, and disabling the remote-control key, etc. At this time, the transport mode needs to be deactivated to restore the vehicle to normal.

TIRE UPGRADE

This function is used to set the size parameters of refitting or replacing tires.

GEAR LEARNING

The crankshaft position sensor learns crankshaft tooth machining tolerance and saves to the tablet to more accurately diagnose engine misfires. If tooth learning is not performed for a car equipped with a Delphi engine, the MIL turns on after the engine is started. The diagnostic device detects the DTC P1336 'tooth not

learned'. In this case, you must use the diagnostic device to perform tooth learning for the car. After tooth learning is successful, the MIL turns off. This function can complete the self-learning of the gearbox and improve the quality of shifting.

After the engine ECU, crankshaft position sensor, or crankshaft flywheel is replaced, or the DTC 'tooth not learned' is present, tooth learning must be performed.

POWER BALANCE

The cylinder power balance test can locate cylinders that are causing a power deficit and not contributing to the balance and performance of the engine. Using this test in conjunction with cylinder compression and cylinder leakage tests can identify the problem.

This test typically measures the speed drop of each cylinder and tests its effectiveness compared to other cylinders. It measures the amount a particular cylinder contributes to the total power output of the engine. The total output of an engine is the sum of all the power produced by each cylinder. The cylinder power balance test uses the effect of the cylinder on the engine speed to determine this power. When the engine is running, the spark plug or primary circuit is grounded. This prevents the spark plug from firing in that cylinder, thus preventing combustion in that cylinder.

When that cylinder is not operating, the engine speed should drop. The drop in engine speed is recorded and compared to the drop when other cylinders are eliminated.

If all cylinders in an engine produce the same amount of power, the drop in engine speed is equal for all engine speeds in the cylinder power balance test. If one cylinder does not contribute much to the total power output of the engine, then the speed drop for that cylinder will be more than the speed drop for the other cylinders during the power balance test. When an engine is running poorly, it is usually caused by one or more cylinders not producing as much power as the other cylinders.

A cylinder power balance test can identify cylinders with low productivity. Ignition or fuel is disabled for each cylinder and a drop in RPM is recorded at a specific speed (800-1000RPM).

The engine analyzer does the same thing as this manual cylinder power balance test. It tests each cylinder and compares the results. When the analyzer is not available, the technician can disconnect the plug bushing from its corresponding spark plug or distributor connection long enough to disable the desired cylinder.

Please note that the RPM will drop when that cylinder is disabled. If the drop in one cylinder is not consistent with the other cylinders, this is an indication of a problem with that cylinder.

This feature is suitable for power balancing when replacing or repairing cylinders.

ELECTRONIC PUMP ACTIVATION

Use this function to activate the electronic water pump before venting the cooling system.

EEPROM

The EEPROM adapter can read the car anti-theft password, back up, read and write and restore anti-theft data, and flash ECU data. Usually, this function is used in conjunction with IMMO or ODO reset.

***Note**

- a) The EEPROM adapter is not included in this product. Please purchase it separately if you need it.

6 REPORT

Diagnostic Report is used for viewing and printing the saved files, such as Live Data, Trouble codes or pictures generated in the process of diagnosis, users also can view a record of which cars have been previously tested. It includes 3 parts:

- **Report**
- **Replay**
- **File Management**



Fig 6-1

REPORT

This feature provides a history of diagnostic reports, where you can view and delete the vehicle's diagnostic reports according to your needs.

Report	
GM 2021-05-15 10:59:36	Delete
日产 2021-05-12 16:18:37	Delete
DEMO 2021-05-12 14:31:24	Delete

Fig 6-2

When you open the report, located in the header of the table is the studio information you filled in advance in the system setup, then the information of the vehicle, including the diagnosis date and time, VIN, vehicle brand, diagnosis path, etc., as shown as below:

Report SN:D8-000009

Workshop Information

Company :	Address :
Website :	Telephone :
Mailbox :	Contact Person :

Time:2021-06-01 13:45:58	VIN:
Mileage: 0 km	Vehicle Name: GM
Diagnosis Route:	

Engine Control Module Exit Print PDF Report

Fig 6-3

■ Print PDF Report

As you can see, you also could click " **Print PDF Report** " at the bottom right corner to output the pdf report. If you need to close the report, you could tap on the button "**Exit**".

Please follow the below steps to print your report▼

Step 1: Install an APP that can drive your target printer. Add the printer and input the IP address of the printer in the APP, or you can contact your dealer for help.

Step 2: Back to the Android main menu, go to Settings -> Printing-> Turn printer on.

Step 3: Report-> Choose report-> Print PDF Report-> Print

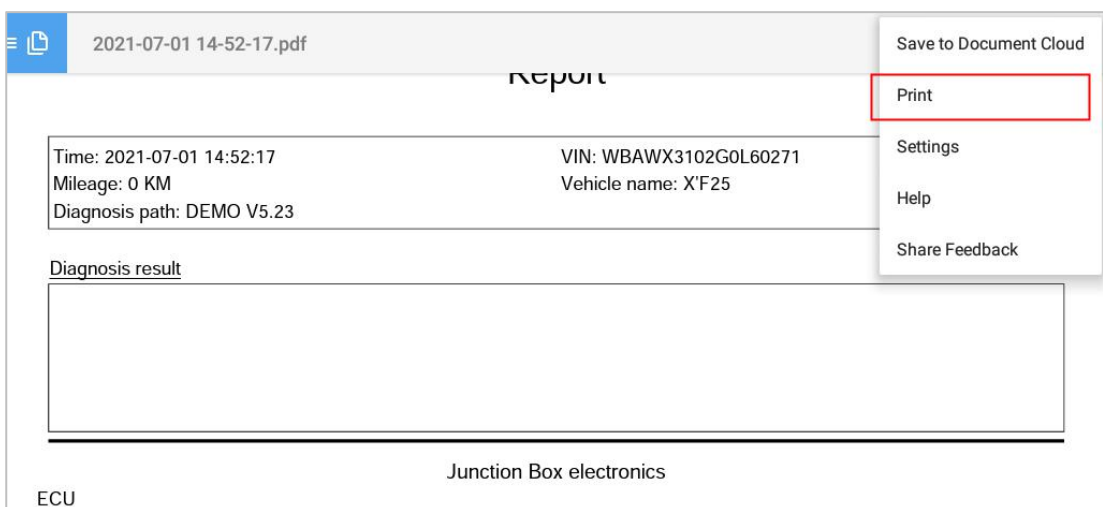

Fig 6-4

Step 4: Click the top-left corner of the screen and choose the printer you added before. Then click the button on the right to print.

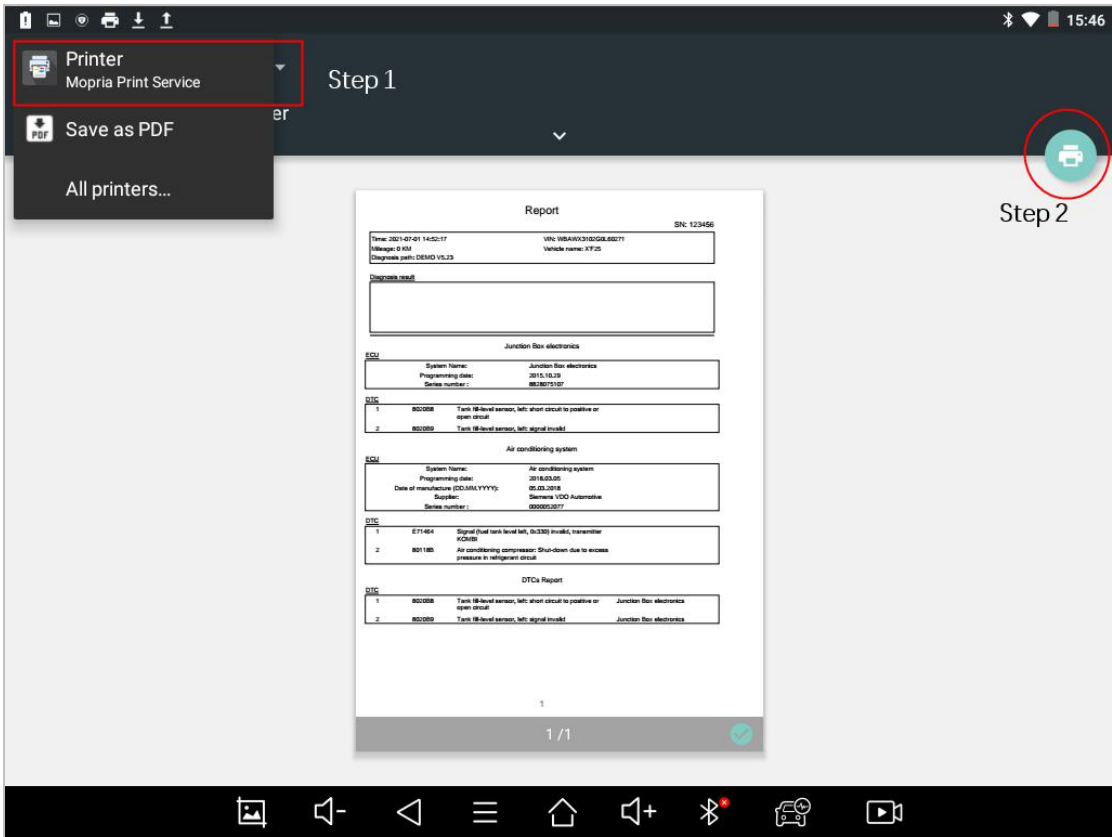
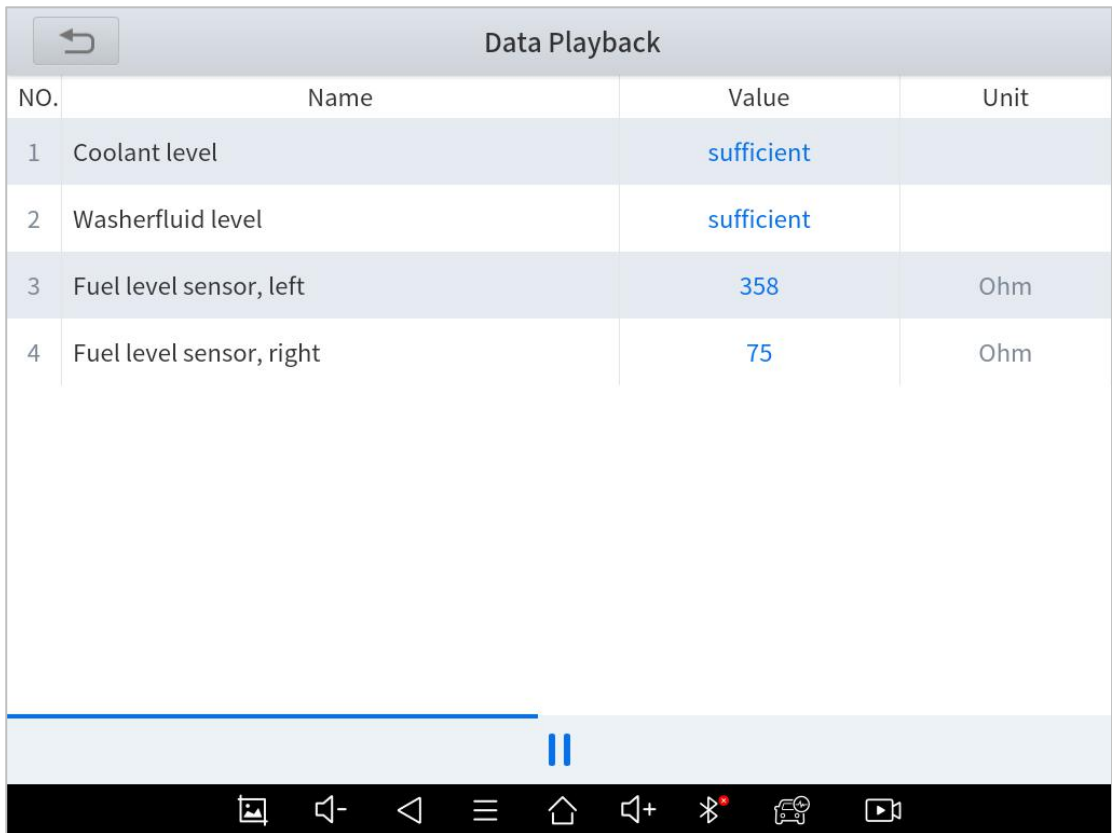

Fig 6-5

REPLAY

This function allows you to replay the living data recorded during the diagnosis process.

Before replaying the living data, please make sure you click on the "Record" button during the diagnosis



The screenshot shows a mobile application interface titled "Data Playback". At the top left is a back arrow icon. Below the title is a table with four columns: "NO.", "Name", "Value", and "Unit". The table contains four rows of data. Below the table is a playback control bar with a blue progress indicator and a pause button. At the bottom is an Android-style navigation bar with icons for gallery, volume, navigation, home, volume, Bluetooth, and video.

NO.	Name	Value	Unit
1	Coolant level	sufficient	
2	Washerfluid level	sufficient	
3	Fuel level sensor, left	358	Ohm
4	Fuel level sensor, right	75	Ohm

Fig 6-6

FILE MANAGER

This function allows you to check and delete files on the device. Please use this function under the guidance of professionals. Ordinary users are not recommended to use it by themselves!

7 SETTINGS



Fig 7-1

Click the Settings button to adjust the default settings and view information about the D8 Smart Diagnosis System. There are seven options available in the system settings:

- **Language**
- **Units**
- **My Workshop Info**
- **VCI Info**
- **About**

LANGUAGE

The languages supported by this device are listed in **Settings**. In areas outside the English area, the default language is English and the local official language. Users can switch between English and local official languages on the device by themselves. If you need to switch other languages, please contact the dealer to unbind the current language configuration and rebind it to the language configuration you need to switch. After the configuration is successfully changed, you can switch the target language.

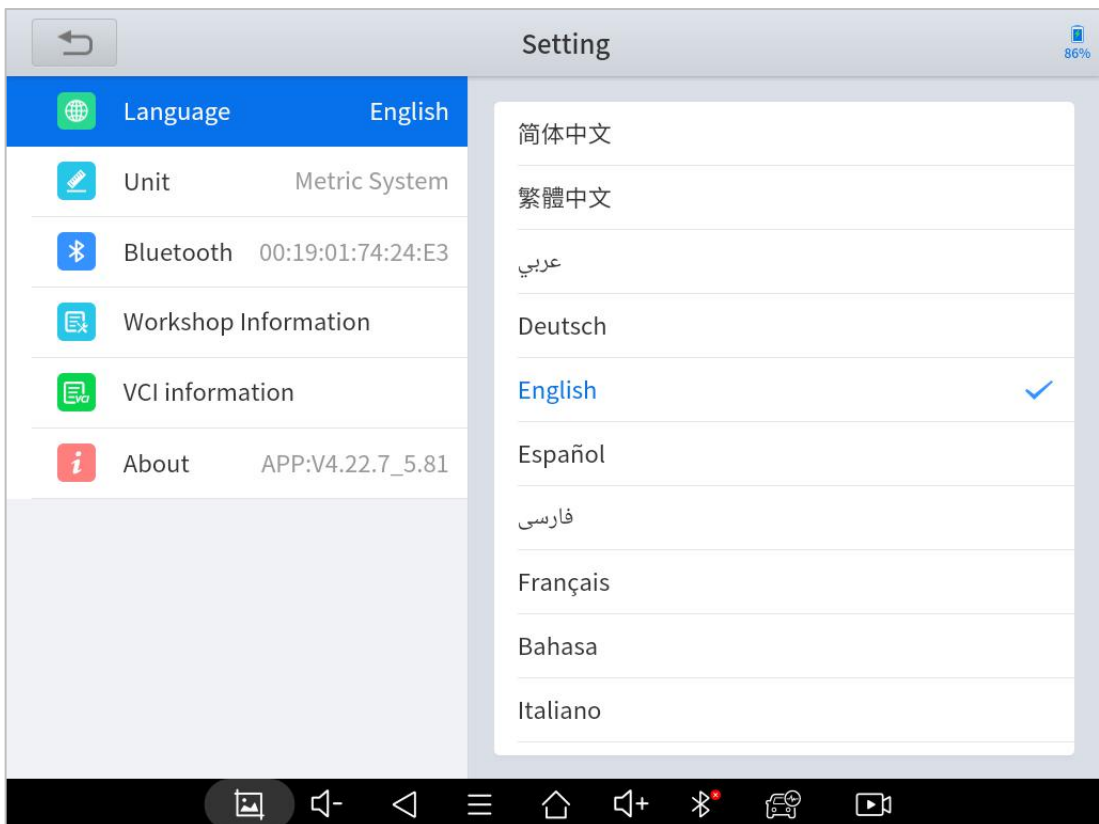

Fig 7-2

Note: The types and quantities of languages supported are subject to the actual language types displayed on the device.

■ Please follow the steps below to switch languages ▼

Step1: Contact your dealer and leave a message about the language you need and the S/N of your device

Step2: **Settings->Language->Choose language**

Step3: **OS Settings->Language & input->Choose Language**

Step4: Back to **Upgrade**

UNITS

You can switch the unit used by the system. D8 Smart Diagnosis System provides you with **Metric, Imperial, and U.S. units**. You can directly click on the unit you need, after the switch is successful, a blue checkmark will be displayed behind the unit's name.

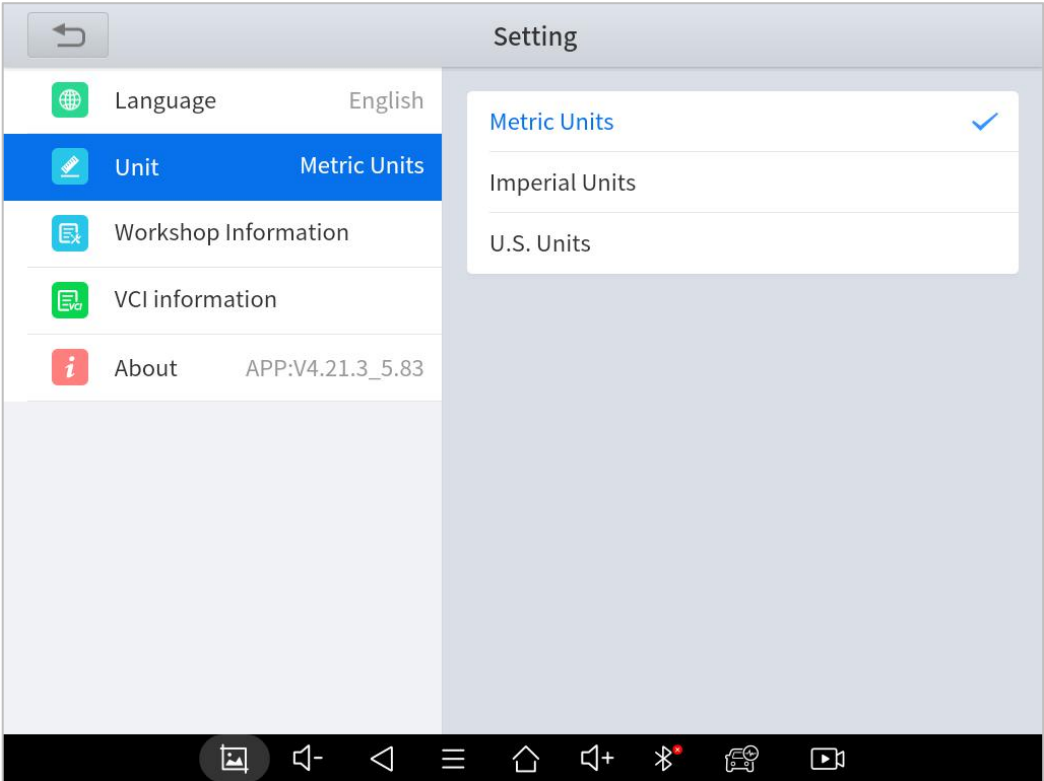

Fig 7-3

MY WORKSHOP INFO

Click on **My Workshop Information**, you can input your workshop information here. As shown in the figure below, you just need to fill in the valid information in the corresponding column and click "**SUBMIT**". And then it will show your workshop information in the report when you generate a diagnostic report, including your company name, address, website, telephone, and mailbox.

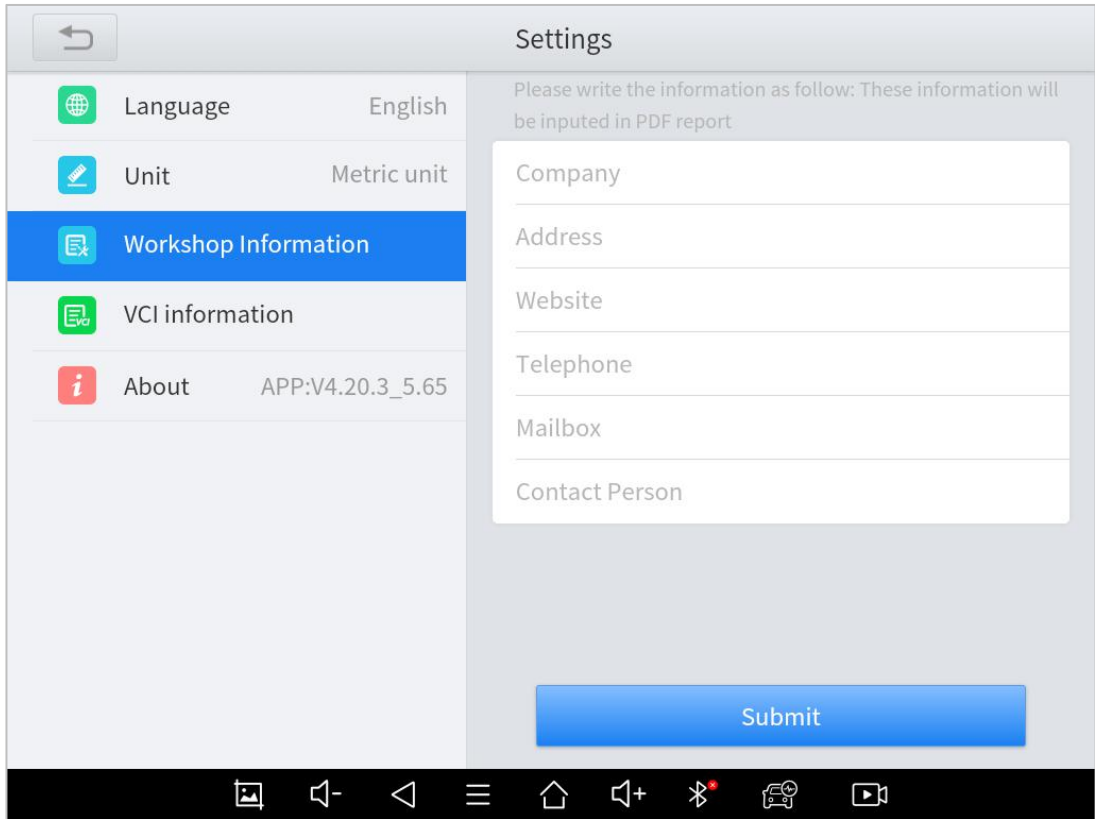

Fig 7-4

VCI INFORMATION

You can view the VCI information here, including the VCI firmware name, the latest firmware version, the currently used firmware version, and the VCI firmware type.

***Note:**

The diagnosis tablet supports automatic firmware update, please make sure that the device is connected to the network when you enter the diagnostic software and the firmware will be automatically updated to the latest version.

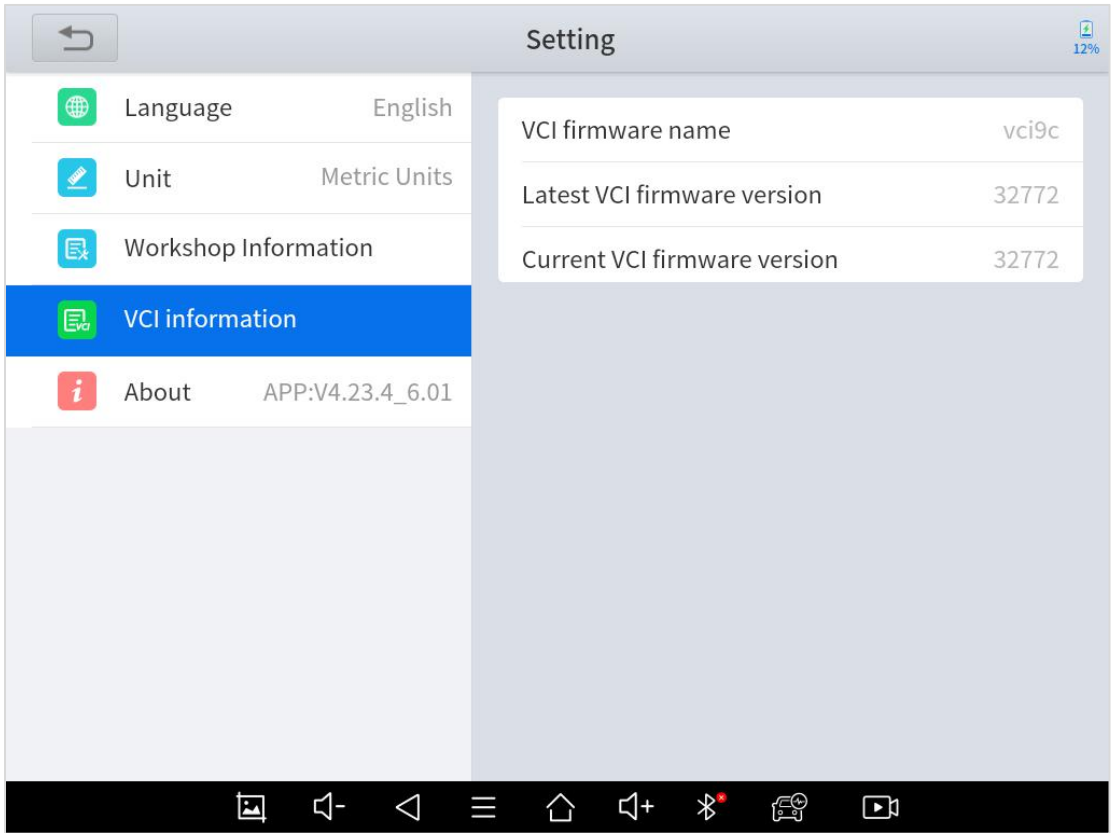

Fig 7-5

ABOUT

Tap on **ABOUT**, you can check the serial number and APP version on here.

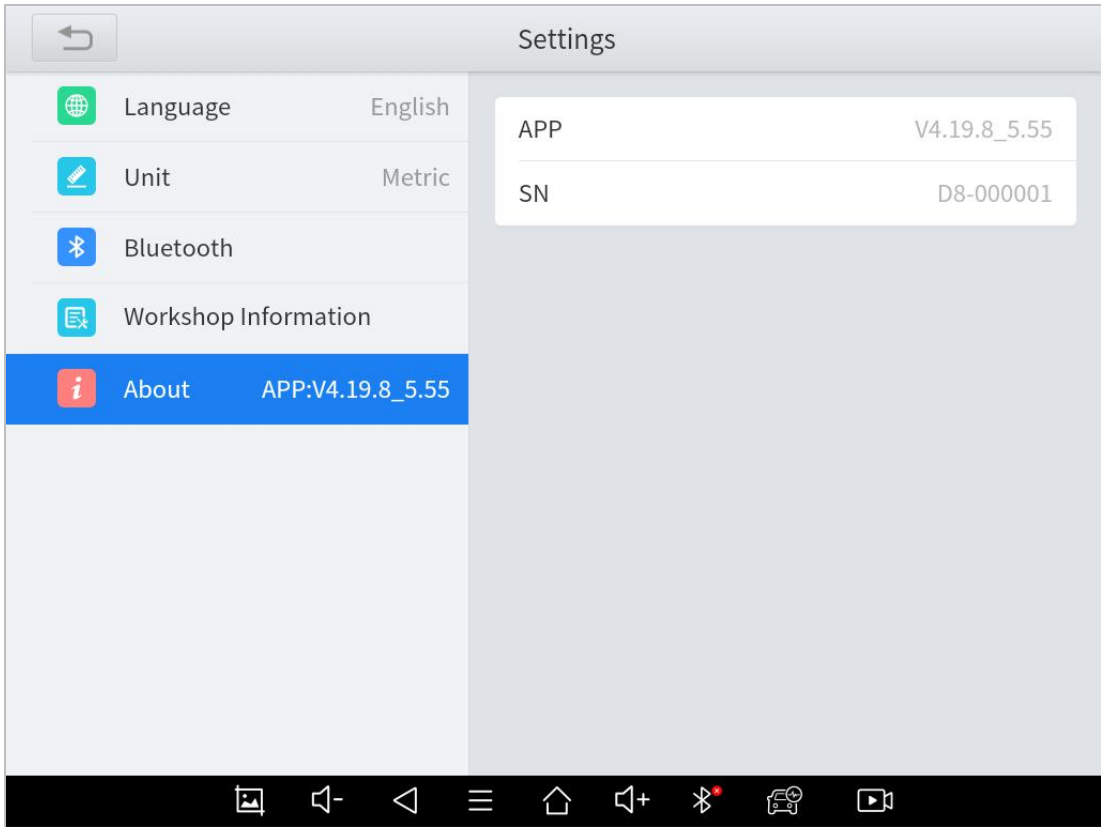

Fig 7-6

8 REMOTE ASSISTANCE

Tap on "**Remote**" to start the TeamViewer quick support program, which is a simple, fast, and secure remote-control screen. You can use this application to enable them to control your tablet on a PC through the TeamViewer software, thereby obtaining temporary remote support from XTOOL's technical support centre.

Tablets and mobile devices running TeamViewer are identified by a globally unique ID. When the remote application is started for the first time, the ID will be automatically generated according to the hardware characteristics and will not be changed in the future. This TeamViewer ID can individually access all TeamViewer clients.

Before launching the remote desktop application, make sure that the tablet is connected to the Internet so that you can access the tablet to receive remote support from a third party. If you encounter problems and are not able to solve them, you could open this application and ask for remote assistance.

To obtain remote support from your partners or XTOOL After-service Center:

1. Turn on the power of the tablet.
2. Click **Remote** in the diagnosis application. The TeamViewer screen is displayed, and the device ID will be generated.

3. Your partner must install the remote-control software on his/her tablet by downloading the full version of the TeamViewer program (<http://www.teamviewer.com>) online, and then start the software on his/her tablet at the same time, to provide support and remote control of the tablet.
4. Provide your ID to the partner or XTOOL technician, and then wait for him/her to send you a remote-control request.
5. A pop-up window will be shown asking you to confirm to allow the remote-control program to control your device.
6. Click **Allow** to accept, or click **Reject** to reject.

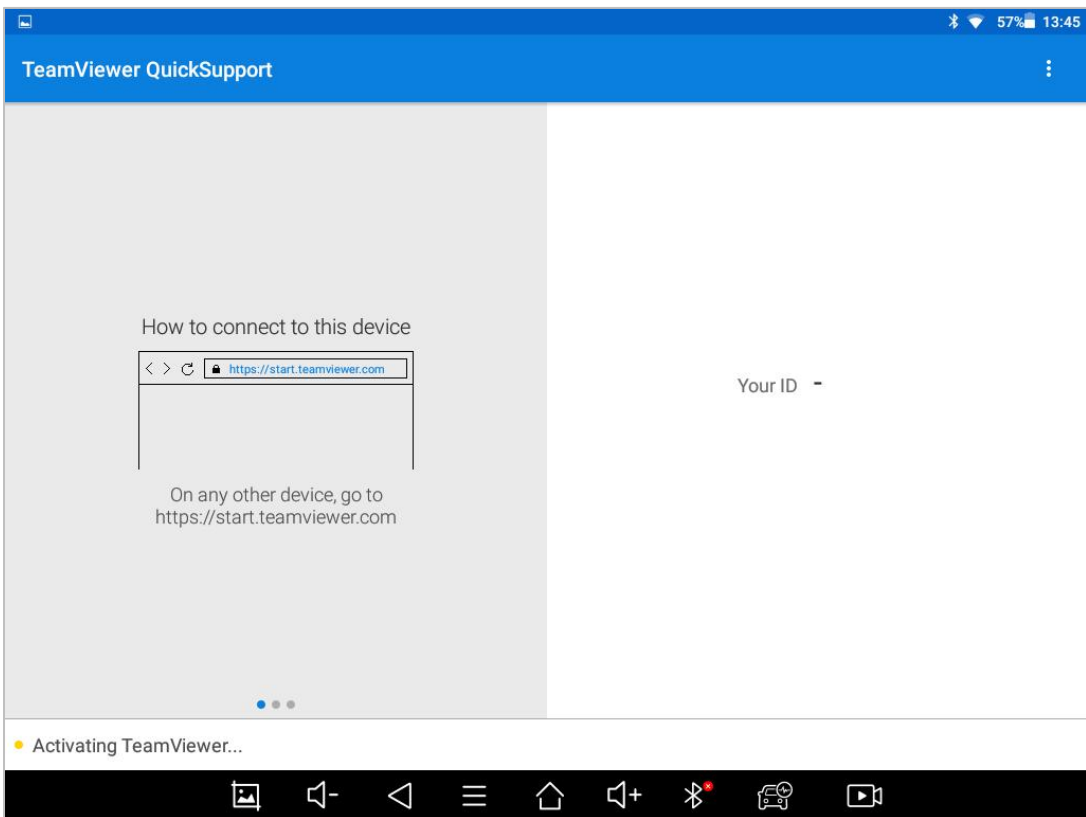

Fig 8-1

9 FAQ

Q1: FAILED TO GENERATE DIAGNOSIS REPORT

1. Currently only perform diagnostic functions, that is, read ECU information, read code and clear code, live data, freeze frame, which can trigger a diagnostic report. Other functions, such as immobilization and maintenance services will not be displayed in the report.
2. After entering the diagnosis menu, you need to perform one specific function before the system can generate a diagnosis report normally.
3. After the diagnosis is completed, you need to step back to the previous menu step by step to generate the diagnosis report successfully. If the APP is killed directly, the report cannot be triggered.
4. If the report still cannot be generated after troubleshooting according to the above prompts, please try to exit the APP, enter the system settings, and then choose to clear the APP cache.

Enter the path: Setting>>Apps>>Diagnosis>>Clear Cache

Sample as follows:

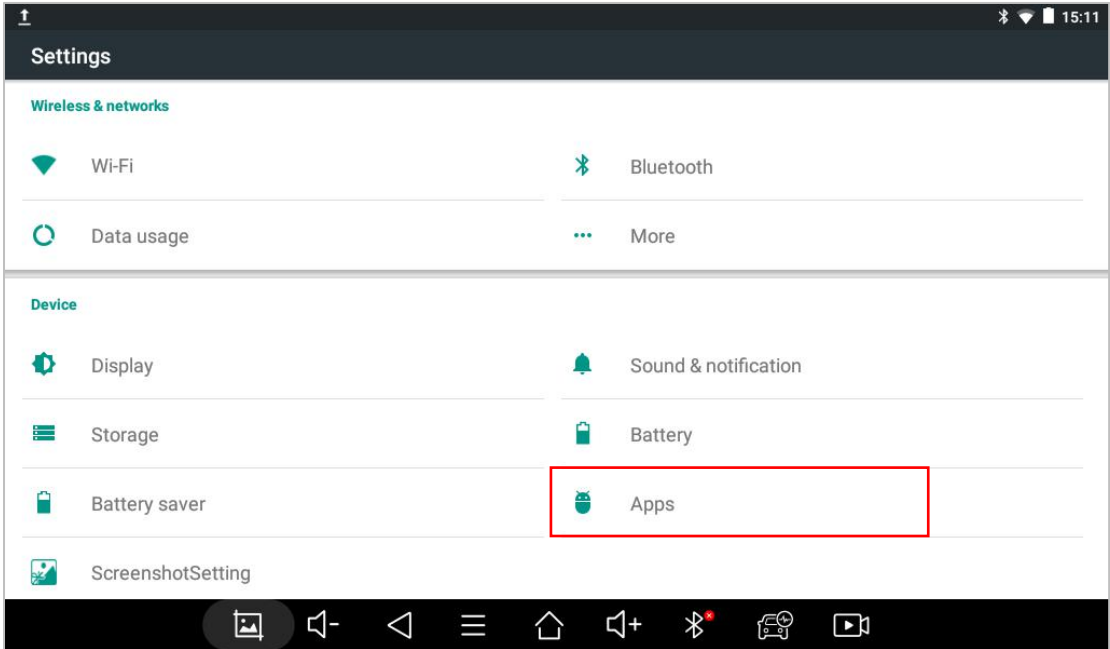

Fig 9-1

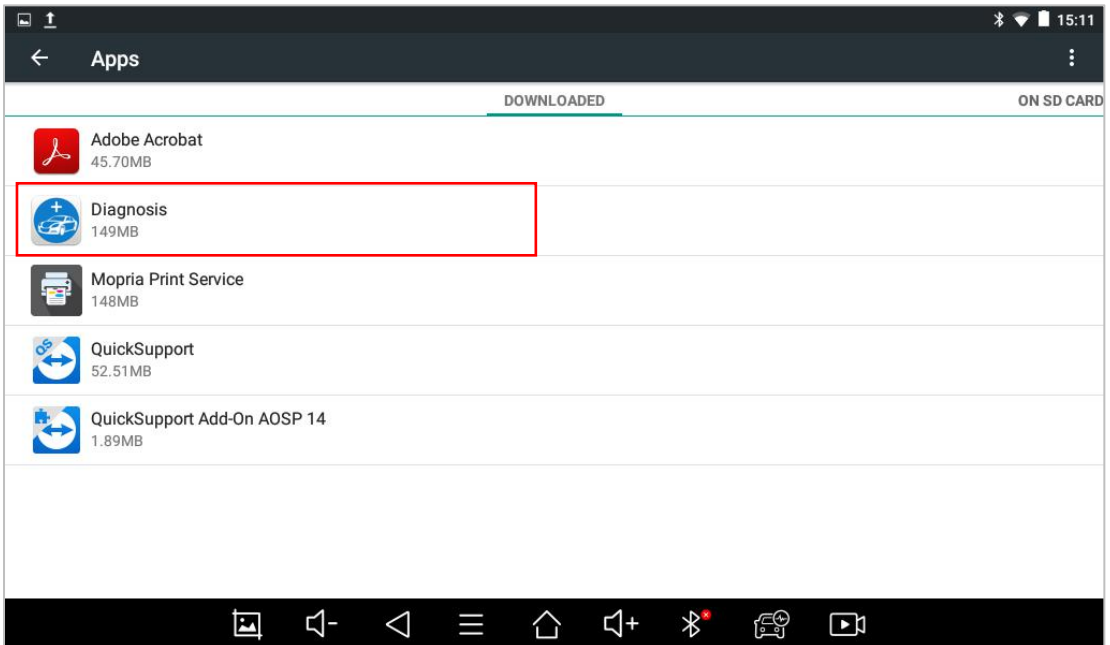

Fig 9-2

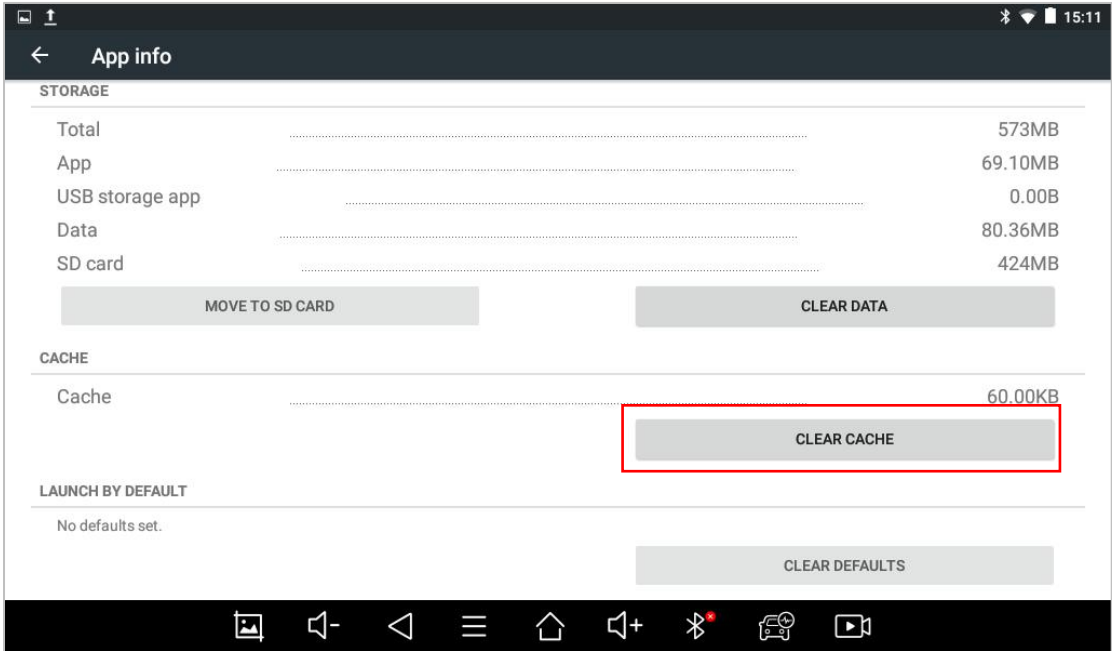

Fig 9-3

Q2: HOW TO PRINT DIAGNOSIS REPORT

The XTOOL device is compatible with third-party print drivers. You can download the printer driver you need in the browser that comes with the tablet to install it, and then set your printer in the OS settings. After the setting is completed, you can print it in the **Report**.

Q3: FAILED TO EXTRACT FILES

Since the XTOOL tablet is equipped with an Android system, you have to confirm the system type of receiver.

For Android: supports transferring files via Bluetooth, USB cable, etc.;

For IOS: only supports transferring files through a wired connection (Bluetooth connection is not available).

Q4: MAILBOX SUPPORTED

The diagnosis tablet supports various mailboxes, including Hotmail, outlook, yahoo and Gmail, etc. When you set up the email, please make sure that the email client configuration address you entered is correct.

Q5: HOW TO MAKE AN APPOINTMENT FOR REMOTE SUPPORT

Please contact your dealer, or send an email to our technical support center. (Email address: supporting@xtooltech.com) And our technical support team will confirm the time of remote support with you.

Q6: HOW TO GENERATE AND UPLOAD DIAGNOSTIC LOG FILES

The D8 tablet will automatically generate and store the diagnostic logs. When the device is connected to the Internet, it will automatically upload all the stored diagnostic logs to the backend system.

Q7: HOW TO SWITCH LANGUAGE

1. Contact your dealer and leave a message about the language you need and the S/N of your device, The technician will modify the language configuration for you in the backend system.
2. **Settings->Language->**Choose language
3. Back to **Updates** to update all the software again

Q8: FAILED TO DIAGNOSE VEHICLE

1. Contact your dealer to confirm whether the vehicle model is supported by the scan tool you owned.
2. Check whether the vehicle is properly connected (e.g. whether the ignition is ON, and the diagnosis of some vehicle need to turn on the engine), If your tablet is equipped with a VCI box, please check the status of VCI box indicator.
3. Confirm whether you have entered the correct diagnosis menu.

4. Confirm whether the **AUTO-SCAN** function can assist you to enter the correct diagnosis menu, or whether **OBDII** function work.
5. Check whether the software is the latest version, if not, please update to the latest version first.

Q9: FAILED TO ACTIVATE OR REGISTER

- For 'Activation Failed'

Generally caused by network instability, please switch to a more stable network and try to activate again.

- For 'Registration Failed'

Generally, it is caused by the connection timeout or the sending timeout, please check whether you have blocked the outgoing network traffic to non-US regions like China. We recommend that you unblock and try to register again.

Q10: FAILED TO TURN ON WHEN CHARGING

In the charging state, you need to first press the power button to light up the screen(showing the charging status). Then press and hold the power button for 4-5 seconds until the boot animation is shown on screen.

Q11: FAILED TO OPEN THE DIAGNOSIS APP

The tablet has to connect to the network every 30 days, otherwise, the diagnosis app will be locked and disabled until the device is connected to the network.

SHENZHEN XTOOLTECH INTELLIGENT CO., LTD

Company address: 17&18/F, Building A2, Creativity City, Liuxian Avenue,
Nanshan District, Shenzhen, China

Factory address: 2/F, Building 12, Tangtou Third Industrial Zone, Shiyan Street,
Baoan District, Shenzhen, China

Service-Hotline: 0086-755-21670995/86267858

Email: marketing@Xtooltech.com

Fax: 0755-83461644

Website: www.Xtooltech.com